

Dual PNP Small Signal Transistor

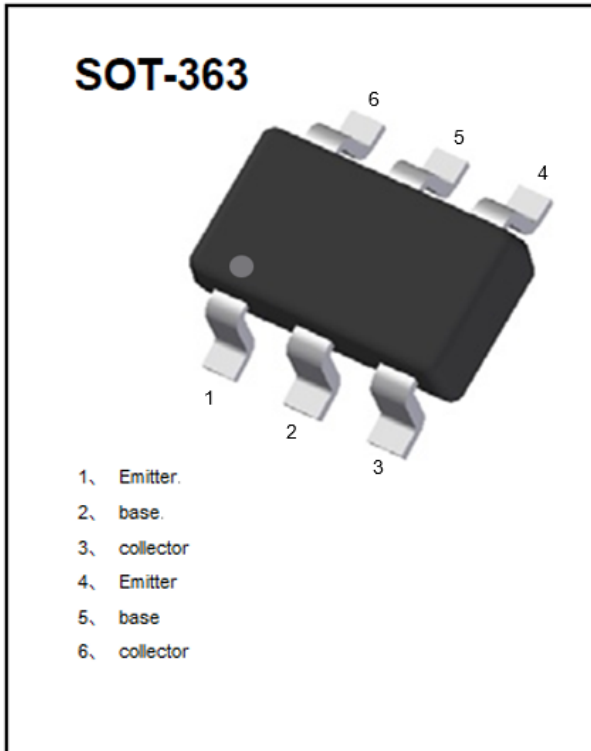

Features

- Epoxy meets UL-94 V-0 flammability rating
- Surface mount package ideally Suited for Automatic Insertion
- PNP

Mechanical Data

- **Package:** SOT-363
- **Terminals:** Tin plated leads, solderable per J-STD-002 and JESD22-B102
- **Marking:** 3F

Equivalent circuit

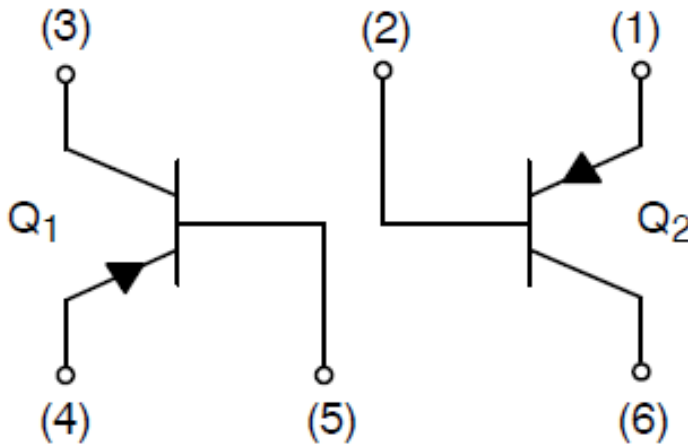



BC857BS

■Maximum Ratings (Ta=25°C Unless otherwise specified)

Q1&Q2-PNP

Item	Symbol	Unit	Conditions	Value
Collector-Base Voltage	VCBO	V	IC=-10μA,IE=0	-50
Collector-Emitter Voltage	VCEO	V	IC=-10mA,IB=0	-45
Emitter-Base Voltage	VEBO	V	IE=-10μA,IC=0	-5
Collector Current	IC	mA		-100
Total Device Dissipation	PC	mW		300
Junction Temperature	Tj	°C		-55 to +150
Storage Temperature	TSTG	°C		-55 to +150

■Electrical Characteristics (Ta=25°C unless otherwise specified)

Q1&Q2-PNP

Item	Symbol	Unit	Conditions	Min	TYP	Max
Collector-base breakdown voltage	V _{(BR)CBO}	V	IC=-10μA,IE=0	-50		
Collector-emitter breakdown voltage	V _{(BR)CEO}	V	IC=-10mA,IB=0	-45		
Emitter-base breakdown voltage	V _{(BR)EBO}	V	IE=-10μA,IC=0	-5		
Collector cut-off current	I _{CBO}	nA	VCB=-30V,IB=0			-15
DC current gain	h _{FE}		VCE=-5V,IC=-2mA	220		475
Collector-emitter saturation voltage	V _{CE(sat)}	V	IC=-10mA,IB=-0.5mA			-0.3
Collector-emitter saturation voltage	V _{CE(sat)}	V	IC=-100mA,IB=-5mA			-0.65
Base-emitter Voltage	VBE	V	VCE=-5V,IC=-2mA	-0.6		-0.75
			VCE=-5V,IC=-10mA			-0.82
Transition frequency	Ft	MHz	VCE=-5V,IC=-10mA,f=100MHz		200	

■ Ordering Information (Example)

PREFERED P/N	PACKING CODE	UNIT WEIGHT(g)	MINIMUM PACKAGE(pcs)	INNER BOX QUANTITY(pcs)	OUTER CARTON QUANTITY(pcs)	DELIVERY MODE
BC857BS	F2	Approximate 0.009g	3000	30000	120000	7" reel



■ Characteristics (Typical) Q1&Q2-PNP

Fig. 1 - Static Characteristics

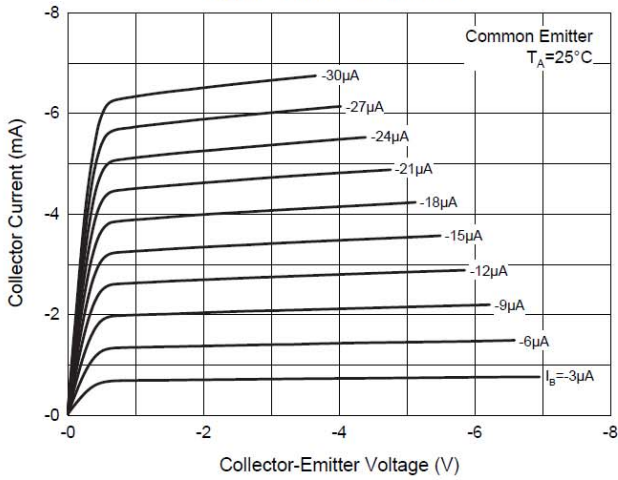

Fig. 2 - DC Current Gain Characteristics

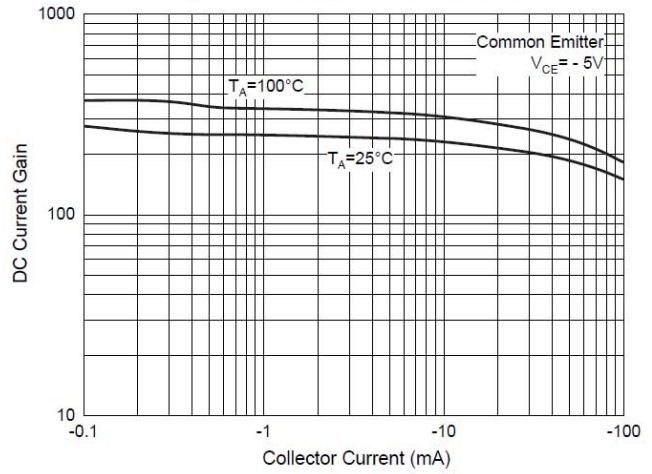

Fig. 3 - Collector-Emitter Saturation Voltage Characteristics

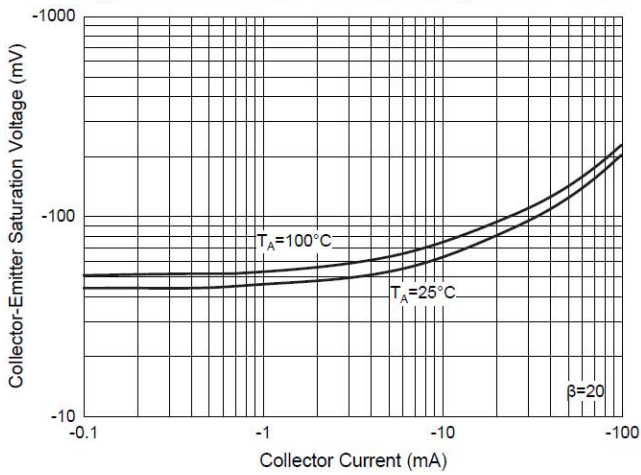

Fig. 4 - Base-Emitter Saturation Voltage Characteristics

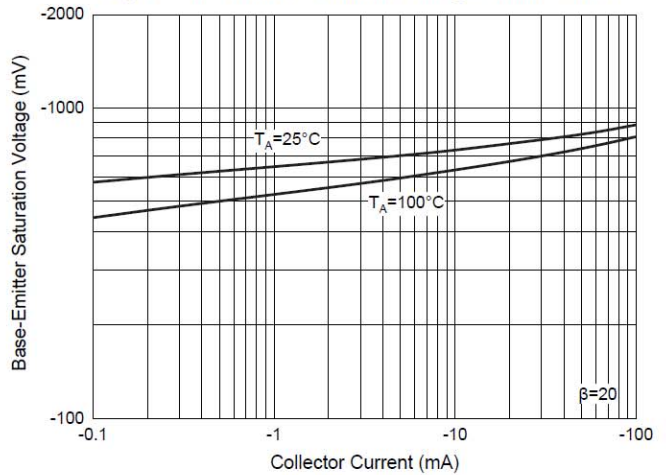

Fig. 5 - Base-Emitter Voltage Characteristics

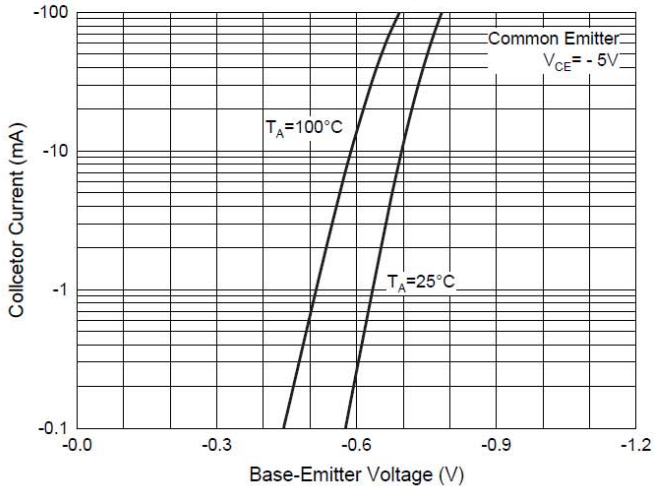
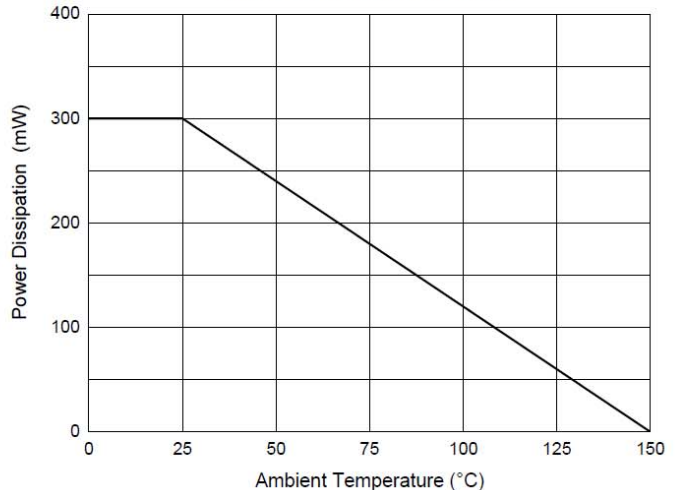

Fig. 6 - Power Derating Curve





BC857BS

■SOT-363 Package Outline Dimensions

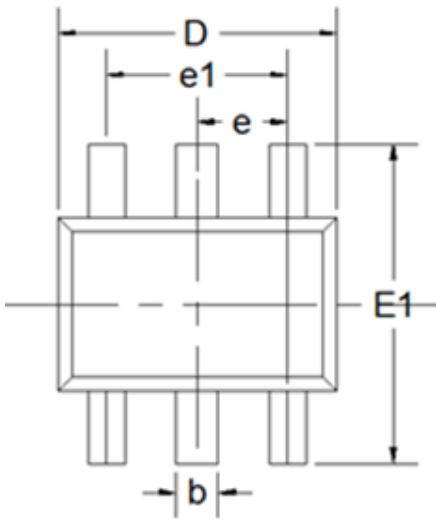

DIM	DIMENSIONS			
	INCHES		MM	
	MIN	MAX	MIN	MAX
A	0.035	0.043	0.9	1.1
A1	0	0.004	0	0.1
A2	0.035	0.039	0.9	1
b	0.006	0.014	0.15	0.35
c	0.002	0.01	0.05	0.25
D	0.071	0.087	1.8	2.2
E	0.045	0.053	1.15	1.35
E1	0.085	0.096	2.15	2.45
e	0.026Typ		0.65Typ	
e1	0.047	0.055	1.2	1.4
L	0.021Typ		0.525Typ	
L1	0.01	0.018	0.26	0.46
φ	0°	8°	0°	8°

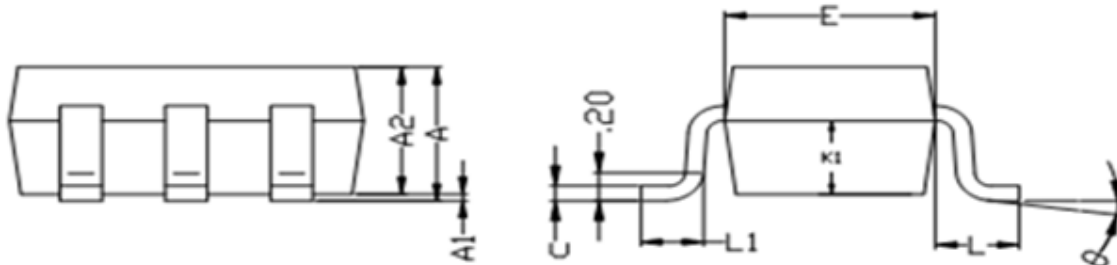

■SOT-363 Suggested Pad Layout

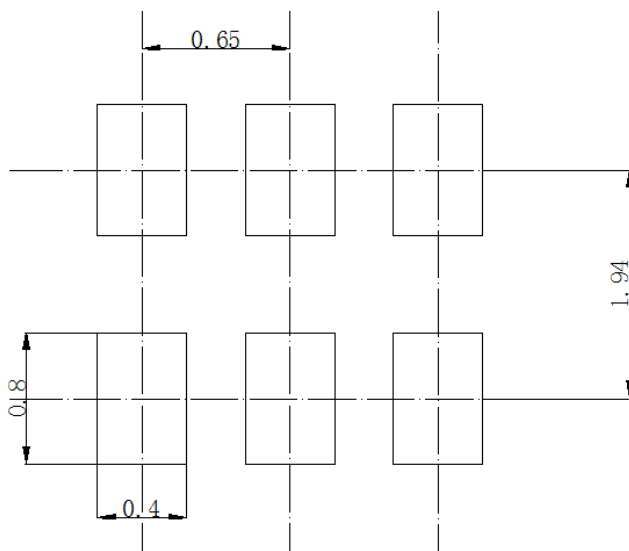

Unit: mm



BC857BS

Disclaimer

The information presented in this document is for reference only. Yangzhou Yangjie Electronic Technology Co., Ltd. reserves the right to make changes without notice for the specification of the products displayed herein to improve reliability, function or design or otherwise.

The product listed herein is designed to be used with ordinary electronic equipment or devices, and not designed to be used with equipment or devices which require high level of reliability and the malfunction of which would directly endanger human life (such as medical instruments, transportation equipment, aerospace machinery, nuclear-reactor controllers, fuel controllers and other safety devices), Yangjie or anyone on its behalf, assumes no responsibility or liability for any damages resulting from such improper use of sale.

This publication supersedes & replaces all information previously supplied. For additional information, please visit our website [http:// www.21yangjie.com](http://www.21yangjie.com) , or consult your nearest Yangjie's sales office for further assistance.