

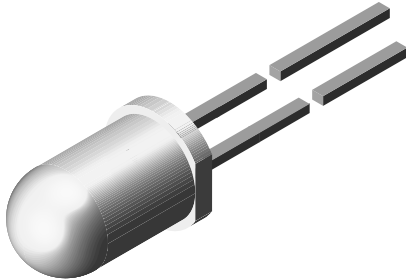

High Power Infrared Emitting Diode, 890 nm, GaAlAs / Double Hetero



94 8389



FEATURES

- Package type: leaded
- Package form: T-1 $\frac{3}{4}$
- Dimensions (in mm): \varnothing 5
- Peak wavelength: $\lambda_p = 890$ nm
- High reliability
- High radiant power
- High radiant intensity
- Angle of half intensity: $\varphi = \pm 22^\circ$
- Low forward voltage
- Suitable for high pulse current operation
- Good spectral matching with Si photodetectors
- Material categorization: for definitions of compliance please see www.vishay.com/doc?99912

APPLICATIONS

- Metering systems

DESCRIPTION

TSPF6200 is an infrared, 890 nm emitting diode in GaAlAs / double hetero (DH) technology with high radiant power, high speed, and with typical receiving characteristics, TSPF6200 is molded in a blue gray tinted plastic package.

PRODUCT SUMMARY

COMPONENT	I_e (mW/sr)	φ (°)	λ_p (nm)	t_r (ns)
TSPF6200	55	± 22	890	50

Note

- Test conditions see table "Basic Characteristics"

ORDERING INFORMATION

ORDERING CODE	PACKAGING	REMARKS	PACKAGE FORM
TSPF6200	Bulk	MOQ: 3000 pcs, 3000 pcs/bulk	T-1 $\frac{3}{4}$

Note

- MOQ: minimum order quantity

ABSOLUTE MAXIMUM RATINGS ($T_{amb} = 25$ °C, unless otherwise specified)

PARAMETER	TEST CONDITION	SYMBOL	VALUE	UNIT
Reverse voltage		V_R	5	V
Forward current		I_F	100	mA
Peak forward current	$t_p/T = 0.5$, $t_p = 100$ μ s	I_{FM}	200	mA
Surge forward current	$t_p = 100$ μ s	I_{FSM}	1.5	A
Power dissipation		P_V	170	mW
Junction temperature		T_j	100	°C
Operating temperature range		T_{amb}	-40 to +85	°C
Storage temperature range		T_{stg}	-40 to +100	°C
Soldering temperature	$t \leq 5$ s, 2 mm from case	T_{sd}	260	°C
Thermal resistance junction to ambient	J-STD-051, leads 7 mm soldered on PCB	R_{thJA}	230	K/W

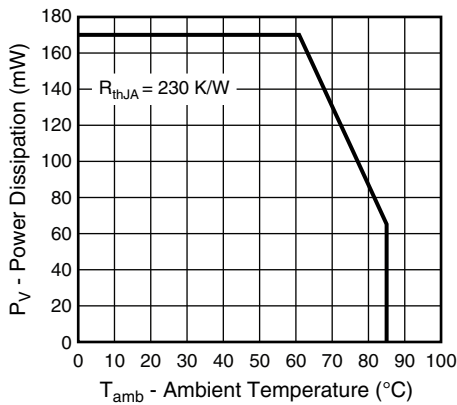

Fig. 1 - Power Dissipation Limit vs. Ambient Temperature

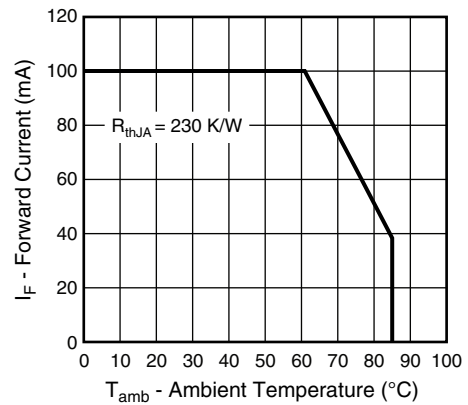

Fig. 2 - Forward Current Limit vs. Ambient Temperature

BASIC CHARACTERISTICS (T _{amb} = 25 °C, unless otherwise specified)						
PARAMETER	TEST CONDITION	SYMBOL	MIN.	TYP.	MAX.	UNIT
Forward voltage	I _F = 100 mA, t _p = 20 ms	V _F	-	1.42	1.7	V
	I _F = 1 A, t _p = 100 μs	V _F	-	3.0	-	V
Temperature coefficient of V _F	I _F = 100 mA	TK _{V_F}	-	-1.7	-	mV/K
Reverse current	V _R = 5 V	I _R	-	-	100	nA
Junction capacitance	V _R = 0 V, f = 1 MHz, E = 0	C _j	-	160	-	pF
Radiant intensity	I _F = 100 mA, t _p = 20 ms	I _e	30	55	90	mW/sr
	I _F = 1 A, t _p = 100 μs	I _e	-	520	-	mW/sr
Short circuit current	E _e = 1 mW/cm ² , λ = 870 nm	I _k	-	10	-	μA
Open circuit voltage	E _e = 1 mW/cm ² , λ = 870 nm	V ₀	-	1.0	-	V
Reverse light current	E _e = 1 mW/cm ² , λ = 870 nm, V _R = 5 V	I _{ra}	-	10	-	μA
Radiant power	I _F = 100 mA, t _p = 20 ms	φ _e	-	40	-	mW
Temperature coefficient of φ _e	I _F = 100 mA	TKφ _e	-	-0.35	-	%/K
Angle of half intensity		φ	-	± 22	-	°
Peak wavelength	I _F = 100 mA	λ _p	870	890	910	nm
Spectral bandwidth	I _F = 100 mA	Δλ	-	40	-	nm
Temperature coefficient of λ _p	I _F = 100 mA	TKλ _p	-	0.25	-	nm/K
Rise time	I _F = 100 mA	t _r	-	50	-	ns
Fall time	I _F = 100 mA	t _f	-	50	-	ns



BASIC CHARACTERISTICS ($T_{amb} = 25\text{ }^{\circ}\text{C}$, unless otherwise specified)

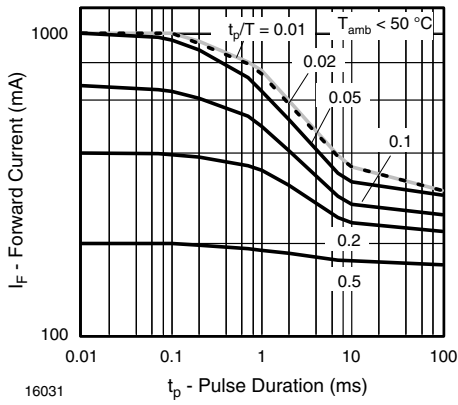

Fig. 3 - Pulse Forward Current vs. Pulse Duration

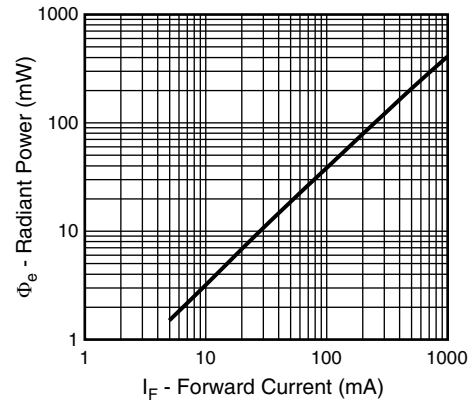

Fig. 6 - Radiant Power vs. Forward Current

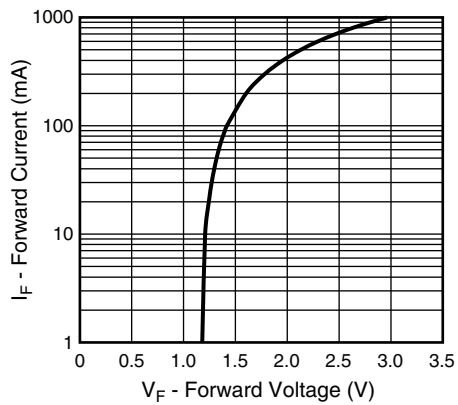

Fig. 4 - Forward Current vs. Forward Voltage

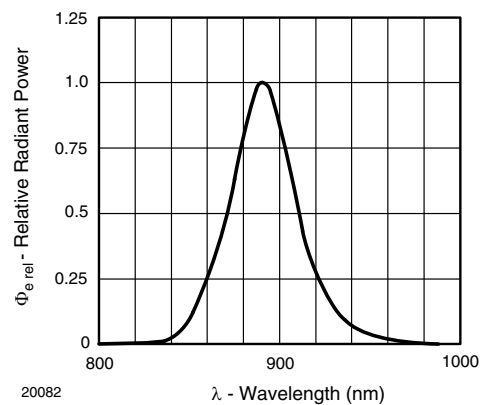

Fig. 7 - Relative Radiant Intensity / Power vs. Wavelength

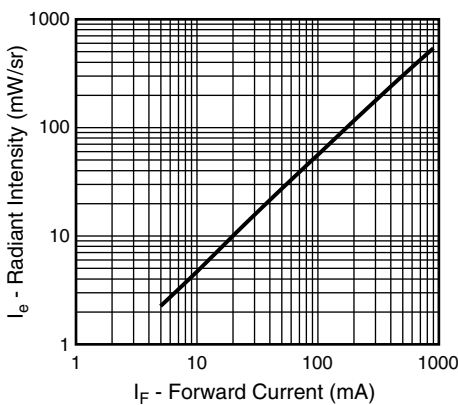

Fig. 5 - Radiant Intensity vs. Forward Current

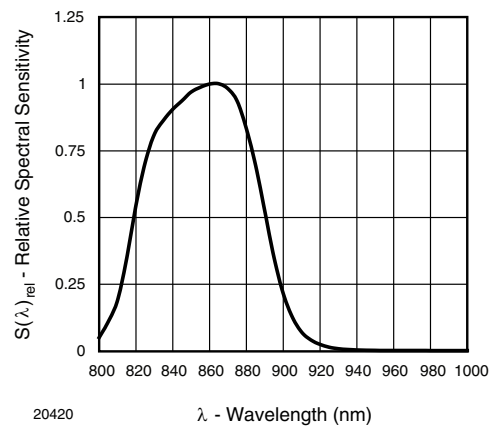

Fig. 8 - Relative Spectral Sensitivity vs. Wavelength

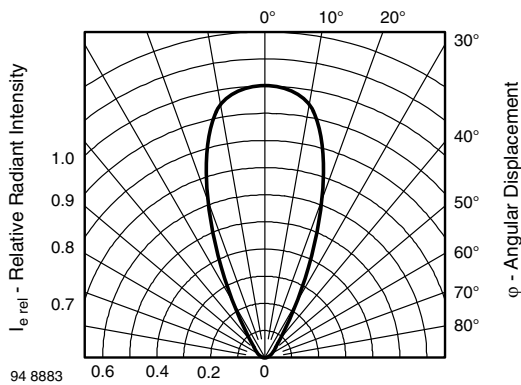
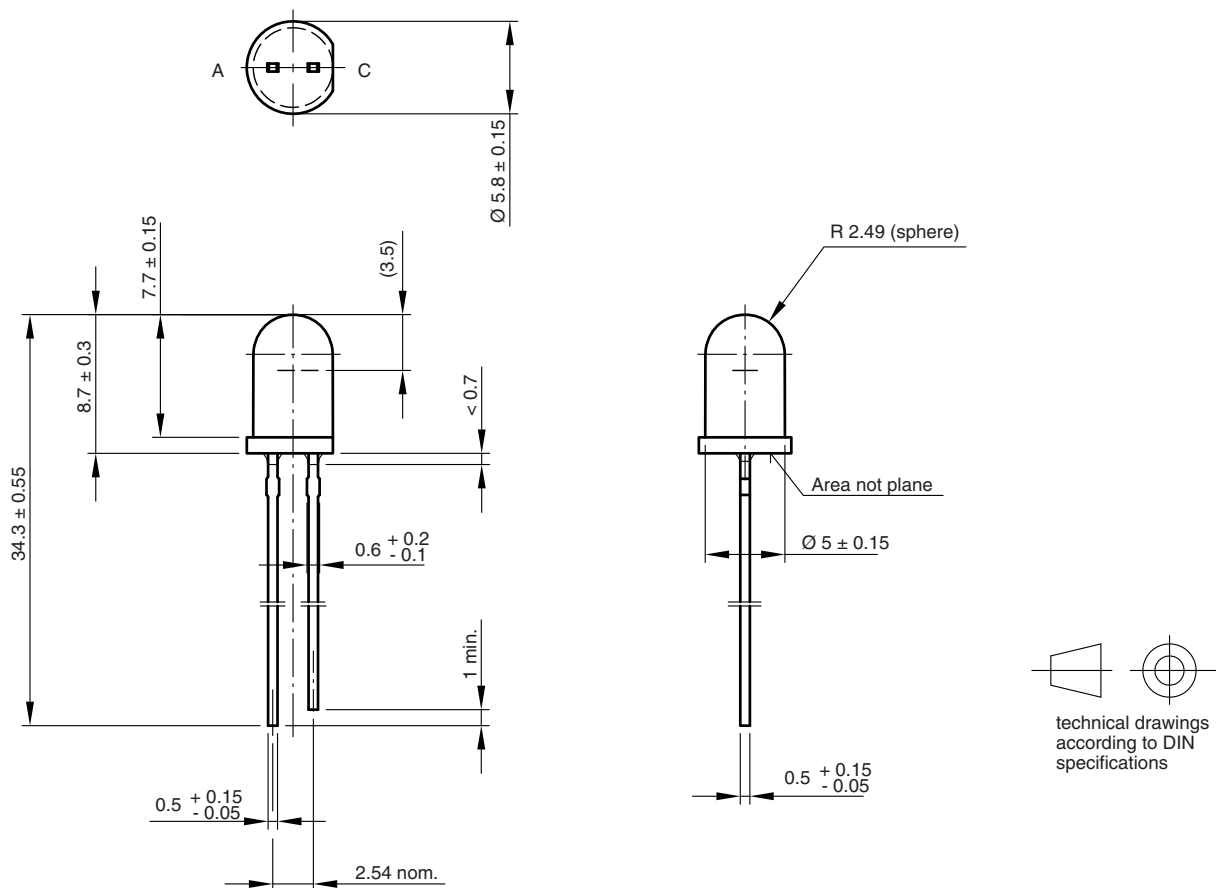

Fig. 9 - Relative Radiant Intensity vs. Angular Displacement

PACKAGE DIMENSIONS in millimeters



Drawing-No.: 6.544-5259.06-4
 Issue: 6; 19.05.09
 19257



Processing Instructions for Mounting of Through-Hole LEDs

By Harald Lunt

INTRODUCTION

Through-hole LED cases usually consist of epoxy casting compounds with duroplastic properties. It is in the nature of things that optical semiconductor devices require transparent materials with the best possible optical features. Unlike standard IC mold compounds, which use reinforcing fillers like glass fibers to achieve better mechanical stability, these optical materials must not be filled. In addition, due to the very small component dimensions, the wall thickness of the casted resin body is also small. All this results in some special aspects regarding mechanical stability during the soldering process to be considered for the processing of leaded LEDs.

THERMAL PROPERTIES OF CURED EPOXY

The chemical cross-linking of thermosetting materials does not allow a real melting when reheated after curing. However, cross-linked materials suffer a softening at an elevated temperature, which is already far below the natural decomposition temperature. The corresponding softening temperature is called the glass transition temperature (T_G). The T_G is not a sharply defined thermodynamic transition, but rather a temperature range over which the mobility of the polymer chains increases significantly, and the base material changes from rigid / glassy to a more rubbery / soft state.

Above T_G , the coefficient of thermal expansion (CTE) of the epoxy increases significantly.

A typical value for T_G is ~ 130 °C and for the increase of CTE from ~ 60 ppm/K to ~ 180 ppm/K below and above T_G , which corresponds to an increase of three times.

KNOWN FAILURE MODES

If the T_G is exceeded too fast, package cracks could emerge, especially from edges of the lead frame, bond wire, or LED chip.

With increasing temperature, the epoxy softens around the highly heat-conductive lead frame, and could be partially detached from the metal so that a delamination could occur. At this stage, previously introduced mechanical tensions (e.g. due to spring effect) may be released, causing the lead frame to slightly move inside the casting resin, and thus bond wires could easily break.

Considering the filigree nature of the bond wire with only about one micro-inch diameter, it is easily comprehensible how important it is to avoid any mechanical stress that could be released during the soldering process.

The following pictures (Fig. 1 to Fig. 4) illustrate the failure modes, based on a practical example:

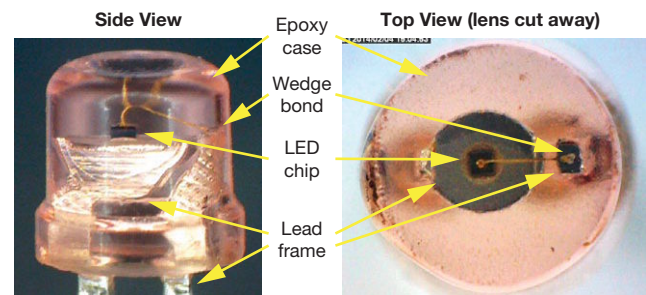

Fig. 1 - Overview Picture of the LEDs

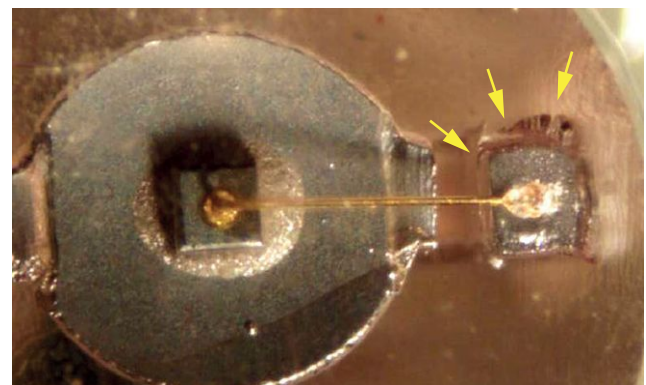

Fig. 2 - Detail View Showing Gaps and Cracks Around Leadframe Post, Indicated by Yellow Arrows

Processing Instructions for Mounting of Through-Hole LEDs

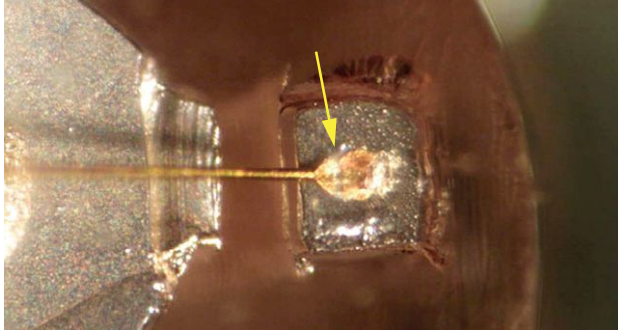

Fig. 3 - Detail View Showing Broken Wedge

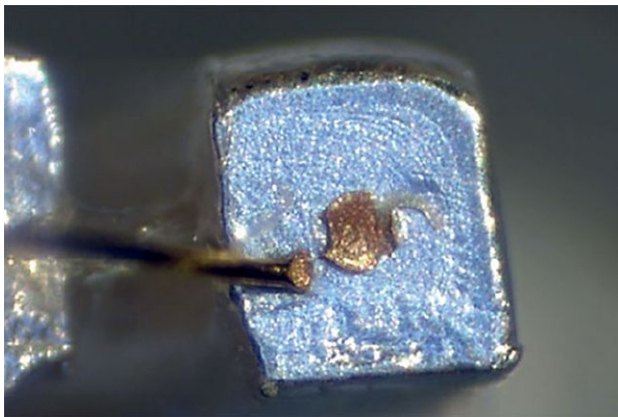

Fig. 4 - Another Example of Broken Wedge After Chemical De-Capsulation

This failure mode could cause immediate open rejects, intermittent behavior, or rather rarely, early fatigue break after some thermal cycles in less severe manifestation, where the bond wire is only pre-damaged after soldering.

ROOT CAUSES

In the example shown above, a plastic holder touching the lower rim of the epoxy case and additional crimping of the LED pins have been used to fix the LEDs on the PCB. Both a spring force applied by the plastic holder and a too-strong crimping of the LED pins contributed to the mechanical damages shown. Even if the maximum temperatures and timing of the soldering profile are within the allowed limits, the described mechanical forces could cause these failure modes.

Furthermore, considering the CTE = 13 ppm/K of steel as a typical lead frame material, an approximate elongation of $\Delta L = \alpha \times L \times \Delta T \approx 30 \mu\text{m}$ happens per 10 mm lead length during the soldering process with 260 °C peak temperature. If the LED is rigidly fixed at the epoxy case by a stiff holder, a pull force occurs during the cooling-down phase while the slower responding epoxy is still in a soft stage.

Further signs of damage could sometimes be observed in the form of cracks at the rim of the epoxy case, at the entry point of the leads into the epoxy case, and as bulging or cracks at points with small wall thickness of the epoxy case.

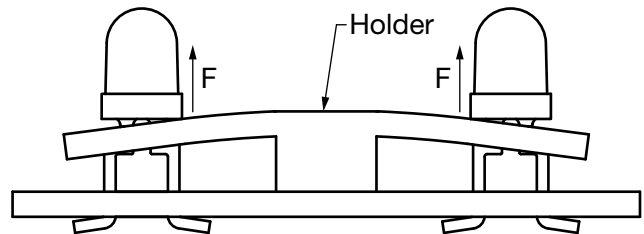

Fig. 5 - Very Critical Holder Design Applying Mechanical Spring Forces to the LEDs

PROCESSING INSTRUCTIONS

The following recommendations should be considered to prevent the LEDs from mechanical stress:

TABLE 1 - RECOMMENDATIONS FOR LED FORMING AND MOUNTING

REF.		
a)		
b)		
c)		
d)		

Processing Instructions for Mounting of Through-Hole LEDs

1. During cutting and lead forming, mechanical force must not be applied to the epoxy case. Suitable measures for strain relief have to be taken (Table 1, a):
 - Do not stress the LED case during lead forming. Use a bending tool, which securely holds the leads at their upper position without touching the epoxy case, so that no force will be transmitted to the epoxy case
 - Minimum 2 mm clearance between the epoxy case and bending point
 - Lead forming has to be done prior to soldering
 - Do not bend the leads more than twice at the same point
2. Generally, do not apply excessive force to the LEDs and allow cooling down of the LED below 50 °C before applying any force from outside
3. The distance between the lower epoxy rim and the closest solder point should be > 2 mm
4. A direct touch down of the epoxy case to the PCB should be avoided
5. The LED pins must be inserted mechanically tension-free into the solder holes (Table 1, a to d)
6. The mounting hole pitch must match the lead pitch of the LED. A proper lead forming according to item "1." may be done to meet this requirement (Table 1, c)
7. Pressure from the top or sides must not be applied to the LED during the whole soldering process, including the cooling-down phase
8. Holders must not create a stiff connection between the epoxy case and PCB, nor apply any spring force to the LED. Component covers or holders must leave some clearance to the epoxy case to avoid stress on the LED (Table 1, b)
9. Crimping should be avoided, or if it is really mandatory, the LED should still have a little clearance so that it could be slightly moved after crimping. The crimping angle should not exceed 45° (Table 1, b)

For further instructions, soldering methods, temperature profiles, and maximum ratings, please refer to individual datasheets and assembly instructions:

www.vishay.com/doc?80092

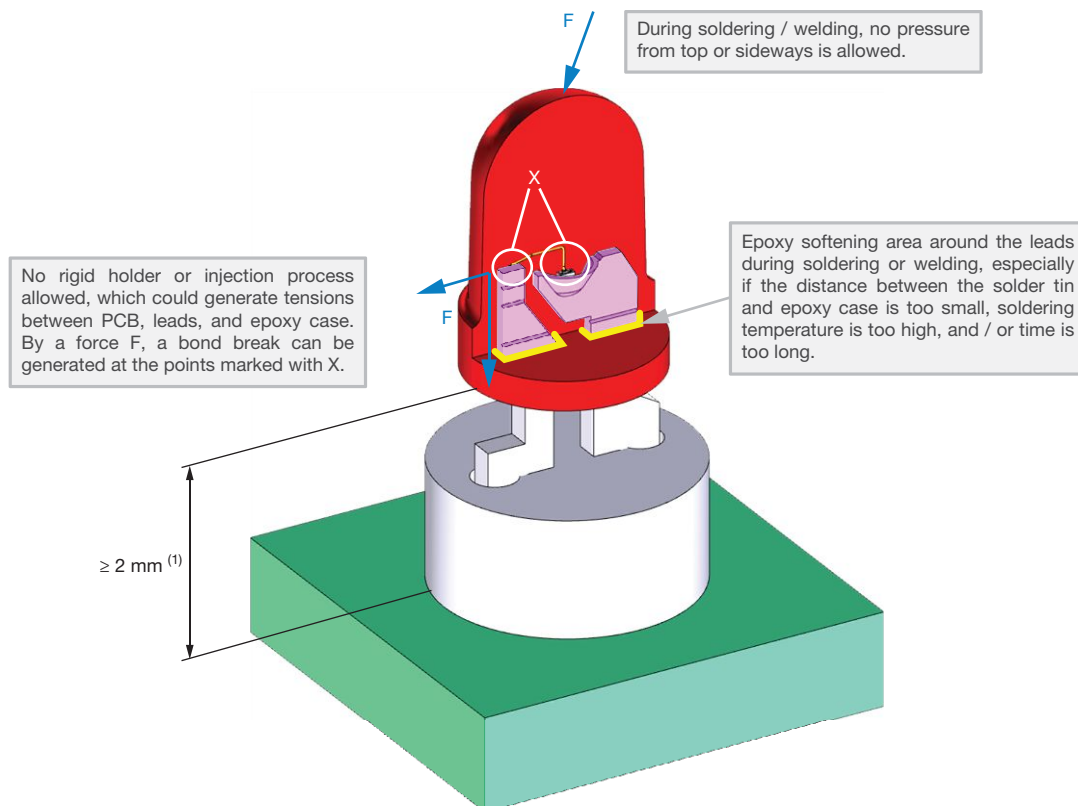

Fig. 6 - Basic Illustration of the Effects

Note

⁽¹⁾ If soldering distance is < 2 mm there is an increased risk to melt / delaminate the casting resin around the connections. Especially in the areas X, the bond connection can be impaired



Eye Safety Risk Assessment of Infrared Emitting Diodes According IEC 62471 (based on CIE S009)

INTRODUCTION

Product safety legislation (e.g. general product safety laws as in Europe the “low voltage- or machinery directives”) requires conformity with “essential requirements”, for instance, protection of health and safety that goods must meet when placed on the market. In this context, compliance with product safety standards for optical sources, such as the standards IEC 60825-1 and IEC 62471, should provide presumption of conformity with these “essential requirements”. The compliance is guaranteed when the goods are classified according the standards as safe, expressed as with e.g. “class 1” or “exempt” for optical sources.

Therefore the operating conditions and the optical and mechanical construction of the final goods define the risk. The risk assessment of LED ⁽¹⁾ applications is not directly related to the LED component.

The risk assessment and classification is to be done with the final product, not with the built-in component. In IEC/EN60825-1 that is expressed by “Laser products that are sold to other manufacturers for use as components of any system for subsequent sale are not subject to IEC 60825-1, since the final product will itself be subject to this standard”. IEC 62471 demands a risk assessment of the lamp (LED) itself. This may be not sufficient for the application, especially when LED arrays are used.

RISK ASSESSMENT FOR LED - APPLICATIONS

Optical sources and optical radiation are covered by different regulative standards. After the latest changes in 2011 the eye safety standards compiled in the following table are applicable for LEDs.

Note

⁽¹⁾ We are using sometimes in our documentation the abbreviation LED and the word light emitting diode also for infrared emitting diodes (IRED). Whenever the term LED is used, IREDS are included when not otherwise noted. That is common usage but not in agreement with IEC 60050-845

EXAMPLE OF APPLICATIONS COVERED BY DIFFERENT OPTICAL RADIATION SAFETY			
	IEC/EN 60825-1 (2007-03) ⁽¹⁾	IEC 62471 (2006) ⁽²⁾	DIRECTIVE 2006/25/EC ⁽³⁾
Fiber optical components	Applicable for laser sources only	x	w
Free air communication IR - remote control (TV, audio, video) IR - communication (IrDA®, home)	Applicable for laser sources only	x	w
Lighting (visible and IR), lamps	-	x	w
IR - photo flash (traffic enforcement)	-	x	w
IR - light barriers	-	x	w
LED indicators	-	x	w
UV - lamps	-	x	w

Notes

- w: for workers environment only
- ⁽¹⁾ **IEC/EN 60825-1 (2007-03), DIN EN 60825-1 (2008-05)**
“SAFETY OF LASER PRODUCTS - Part 1: Equipment classification and requirements”
- ⁽²⁾ **IEC 62471 (2006)**
“Photobiological Safety of Lamps and Lamp Systems”
- ⁽³⁾ **DIRECTIVE 2006/25/EC OF THE EUROPEAN PARLIAMENT AND OF THE COUNCIL**
of 5 April 2006
on the minimum health and safety requirements regarding the exposure of workers to risks arising from physical agents (artificial optical radiation) (19th individual directive within the meaning of article 16(1) of directive 89/391/EEC)



THE DIFFERENT EYE SAFETY STANDARDS FOR LEDs

The standard **IEC (EN DIN) 60825-1** "SAFETY OF LASER PRODUCTS - Part 1: equipment classification and requirements", is applicable to safety of laser products emitting (coherent) laser radiation in the wavelength range 180 nm to 1 mm. In previous editions, LEDs were included in the scope of this standard, and were also included in other parts of the IEC 60825 series, as e.g. in IEC 60825 - Part 12, "Safety of free space optical communication systems used for transmission of information". Currently the standardization philosophy changed, that with the development of lamp safety standards, optical radiation safety of LEDs in general can be more appropriately addressed by lamp safety standards. IEC 62471 now is to be applied to determine the risk group of an LED or product incorporating one or more LEDs.

IEC 60825-1 does not cover the LEDs emitting radiation for indication, illumination, lighting, or data transmission anymore.

However, LEDs formerly assessed as "class 1" of this standard will be safe also when rated by the new standard ("exempt").

A general standard for the safety of incoherent sources was already in the past the **CIE S009** ("Photobiological Safety of Lamps and Lamp Systems"), which later was published as a new common ISO/IEC standard **IEC 62471**. This is equivalent but not in all items identical with the **European Directive 2006/25/EC** with the long title mentioned already above.

The European edition of IEC 62471 as EN 62471 was delayed for some time. A new edition of EN 62471 published in the meantime and a technical report published as part 2: Guidance on manufacturing requirements relating to non-laser optical radiation safety with the new title IEC 62471-2 Ed. 1/TR are available. In Germany this part 2 is published also as technical report as "Beiblatt 1" to the basic standard.

IEC 62471 according the title "Photobiological Safety of Lamps and Lamp Systems" lets assume not only to cover the final product as IEC 60825-1 but especially the lamp. The original text, chapter 6 of IEC 62471 says it requires in first order the classification of the lamp: "This clause is concerned with lamp classification. However a similar classification system could be applicable to luminaires or other systems containing operating lamps".

While in case of e.g. incandescent lamps where e.g. in most cases just one single conventional lamp (bulb) is used for a luminaire the risk assessment can refer to the lamp. In case of LEDs with many LEDs e.g. combined in one luminaire this may be different.

LED manufacturers usually do not know the future application and would have to apply any limit set. Thus, since the risk group allocation bases in any case on the most restrictive limits, the result might be inappropriate for the future application or overly restrictive. As the laser safety

standard IEC 60825-1 also IEC 62471 is to be interpreted like "The final product will itself be subject to this standard". Only this is strictly in agreement with general product safety laws (e.g. in Europe the "low voltage- or machinery directives").

For instance, the EU product safety legislation requires conformity with "essential requirements", e.g., protection of health and safety that goods must meet when they are placed on the common market. In this context, compliance with product safety standards, such as the standards IEC 60825-1 and IEC 62471, should provide presumption of conformity with these "essential requirements".

CLASSIFICATION

IREDs

Most IREDs are emitting in the 800 nm to 960 nm range. Radiation within these wavelengths causes a thermal retina hazard and thermal injury risk of the cornea and possible delayed effects on the lens of the eye (cataractogenesis). In general the IEC 60825-1 is more restrictive in case of the thermal retinal hazard; the cornea/lens limits with the given conditions can be found only in IEC 62471 and in the European Directive 2006/25/EC.

In the past IREDs were classified by the simplified method according IEC 60825-1 comparing the maximum intensity emitted under absolute maximum rating conditions. When the intensity was above that limit, the source size had to be taken into account. With that none of the currently available (July/2008) Vishay IREDs violate the class 1 limit. In case of IEC 62471 and in the European Directive 2006/25/EC all Vishay IREDs are inside the exempt conditions. Only with arrays care must be taken not to violate the cornea/lens limits.

LEDs

Diode emitters in the visible spectrum cover the wavelength range from 400 nm to 780 nm including also wide band white LEDs. LEDs in the visible spectrum are used for lighting, signaling, or as indicators. Therefore the risk assessment is according IEC 62471 and in the European Directive 2006/25/EC.

Here the blue light hazard with the wavelength depending function $B(\lambda)$ is the limiting factor still on the red side of the spectrum. It has to be taken into account up to a wavelength of 700 nm.

The intensity specification of visible LEDs is done in terms of photometric units as Candela (cd). Due to the strong variation of the ratio to the radiometric units used for defining the limits this is more complicated or even confusing for the normal electrical engineer.

Nearly all LEDs are far below the Exempt limits. However, care should be taken on the short wavelength side of the spectrum. Therefore a general statement as for IREDs cannot be given.



Vishay supplies all necessary data for the risk assessment in the data sheet and on request, in case it is not published there. Either via the sales channel or simply the technical support box on the website this data will be available on request.

LEDs are removed from IEC 60825-1. LEDs are to be assessed according IEC 62471 and European Directive 2006/25/EC. All LEDs are moved to the eye safety standard for artificial non coherent sources IEC 62471.

SUMMARY OF INTENSITY / WAVELENGTH DATA ACCORDING EXEMPT GROUP OF IEC 62471		
PART NUMBER	VIRTUAL SOURCE SIZE d (mm)	WAVELENGTH / MAXIMUM INTENSITY AT ABSOLUTE MAX. RATINGS
CQY36N	1.2	950 nm / 2.1 mW/sr
CQY37N	1.2	950 nm / 11 mW/sr
TSAL4400	1.9	940 nm / 80 mW/sr
TSAL6100	3.7	940 nm / 400 mW/sr
TSAL6200	2.4	940 nm / 200 mW/sr
TSAL6400	2.2	940 nm / 125 mW/sr
TSFF5210	3.7	870 nm / 360 mW/sr
TSFF5410	2.1	870 nm / 135 mW/sr
TSFF5510	-	870 nm / 48 mW/sr
TSFF6210	3.7	870 nm / 450 mW/sr
TSFF6410	2.1	870 nm / 135 mW/sr
TSHA4400	1.8	875 nm / 60 mW/sr
TSHA4401	1.8	875 nm / 60 mW/sr
TSHA5200	3.7	875 nm / 125 mW/sr
TSHA5201	3.7	875 nm / 125 mW/sr
TSHA5202	3.7	875 nm / 125 mW/sr
TSHA5203	3.7	875 nm / 125 mW/sr
TSHA5500	2.2	875 nm / 48 mW/sr
TSHA6200	3.7	875 nm / 125 mW/sr
TSHA6201	3.7	875 nm / 125 mW/sr
TSHA6202	3.7	875 nm / 125 mW/sr
TSHA6203	3.7	875 nm / 125 mW/sr
TSHA6500	2.2	875 nm / 48 mW/sr
TSHF4410	1.9	890 nm / 120 mW/sr
TSHF5210	3.7	890 nm / 360 mW/sr
TSHF5410	2.1	890 nm / 135 mW/sr
TSHF6210	3.7	890 nm / 360 mW/sr
TSHF6410	2.1	890 nm / 135 mW/sr
TSHG5210	3.7	850 nm / 420 mW/sr
TSHG5410	2.1	850 nm / 135 mW/sr
TSHG5510	-	830 nm / 54 mW/sr
TSHG6200	3.7	850 nm / 360 mW/sr
TSHG6210	3.7	850 nm / 420 mW/sr
TSHG6400	3.7	850 nm / 135 mW/sr
TSHG6410	2.1	850 nm / 135 mW/sr
TSHG8200	3.7	830 nm / 360 mW/sr
TSHG8400	2.1	830 nm / 135 mW/sr
TSKS5400	1.2	950 nm / 7 mW/sr
TSKS5400S	1.2	950 nm / 7 mW/sr
TSMF1000	1.2	890 nm / 13 mW/sr
TSMF1020	1.2	890 nm / 13 mW/sr
TSMF1030	1.2	890 nm / 13 mW/sr
TSML1000	1.2	940 nm / 15 mW/sr



SUMMARY OF INTENSITY / WAVELENGTH DATA ACCORDING EXEMPT GROUP OF IEC 62471		
PART NUMBER	VIRTUAL SOURCE SIZE d (mm)	WAVELENGTH / MAXIMUM INTENSITY AT ABSOLUTE MAX. RATINGS
TSML1020	1.2	940 nm / 15 mW/sr
TSML1030	1.2	940 nm / 15 mW/sr
TSML1040	1.2	940 nm / 15 mW/sr
TSPF6200	-	890 nm / 90 mW/sr
TSSF4500	2.1	890 nm / 50 mW/sr
TSSS2600	2.0	950 nm / 3 mW/sr
TSTA7100	1.5	875 nm / 100 mW/sr
TSTA7300	1.0	875 nm / 50 mW/sr
TSTA7500	0.5	875 nm / 16 mW/sr
TSTS7100	1.5	950 nm / 50 mW/sr
TSTS7300	1.0	950 nm / 32 mW/sr
TSTS7500	0.5	950 nm / 8 mW/sr
TSUS3400	2.1	950 nm / 35 mW/sr
TSUS4300	2.1	950 nm / 35 mW/sr
TSUS4400	2.1	950 nm / 35 mW/sr
TSUS5200	3.8	950 nm / 50 mW/sr
TSUS5201	3.8	950 nm / 50 mW/sr
TSUS5202	3.8	950 nm / 50 mW/sr
TSUS5400	2.9	950 nm / 35 mW/sr
TSUS5401	2.9	950 nm / 35 mW/sr
TSUS5402	2.9	950 nm / 35 mW/sr
VSLB3940	2.0	940 nm / 110 mW/sr
VSLB3948	2.0	940 nm / 110 mW/sr
VSLB4940	-	940 nm / 110 mW/sr
VSLB9530S	-	940 nm / 95 mW/sr
VSLY3850	-	850 nm / 105 mW/sr
VSLY3943	-	940 nm / 120 mW/sr
VSLY5850	-	850 nm / 900 mW/sr
VSLY5940	-	940 nm / 900 mW/sr
VSMA1094250X02	-	940 nm / 2300 mW/sr
VSMA1094400X02	-	940 nm / 1575 mW/sr
VSMA1094600X02	-	940 nm / 860 mW/sr
VSMA1085250X02	-	850 nm / 2500 mW/sr
VSMA1085400X02	-	850 nm / 1725 mW/sr
VSMA1085600X02	-	850 nm / 915 mW/sr
VSMB10940	-	940 nm / 4.8 mW/sr
VSMB11940	-	940 nm / 4.8 mW/sr
VSMB14942	-	940 nm / 42 mW/sr
VSMB1940	-	940 nm / 12 mW/sr
VSMB1940X01	0.5	940 nm / 12 mW/sr
VSMB2000X01	1.5	940 nm / 60 mW/sr
VSMB2020X01	1.5	940 nm / 60 mW/sr
VSMB294008RG	-	940 nm / 90 mW/sr
VSMB2943RGX01	-	940 nm / 30 mW/sr
VSMB2943SLX01	-	940 nm / 30 mW/sr
VSMB2948	-	940 nm / 30 mW/sr
VSMB2948SL	-	940 nm / 30 mW/sr
VSMB3940X01	0.5	940 nm / 21 mW/sr
VSML3710	0.44	940 nm / 20 mW/sr



SUMMARY OF INTENSITY / WAVELENGTH DATA ACCORDING EXEMPT GROUP OF IEC 62471		
PART NUMBER	VIRTUAL SOURCE SIZE d (mm)	WAVELENGTH / MAXIMUM INTENSITY AT ABSOLUTE MAX. RATINGS
VSMY14940	-	940 nm / 120 mW/sr
VSMY1850X01	0.5	850 nm / 15 mW/sr
VSMY1850ITX01	0.5	850 nm / 15 mW/sr
VSMY1940X01	-	940 nm / 15 mW/sr
VSMY1940ITX01	-	940 nm / 15 mW/sr
VSMY2850	1.5	850 nm / 150 mW/sr
VSMY2850RGX01	-	850 nm / 210 mW/sr
VSMY2853RG	-	850 nm / 50 mW/sr
VSMY2853RGX01	-	850 nm / 70 mW/sr
VSMY2890RGX01	-	890 nm / 175 mW/sr
VSMY2940	-	940 nm / 195 mW/sr
VSMY2940RGX01	-	940 nm / 215 mW/sr
VSMY2941RGX01	-	940 nm / 236 mW/sr
VSMY2943RG	-	940 nm / 75 mW/sr
VSMY2943SLX01	-	940 nm / 75 mW/sr
VSMY29431ORG	-	940 nm / 45 mW/sr
VSMY3850	0.44	850 nm / 25 mW/sr
VSMY385010	-	850 nm / 16 mW/sr
VSMY385010X01	-	850 nm / 17 mW/sr
VSMY3850X01	-	850 nm / 24 mW/sr
VSMY3890X01	-	890 nm / 25 mW/sr
VSMY3940X01	-	940 nm / 24 mW/sr
VSMY5850	-	850 nm / 18 mW/sr
VSMY5850X01	-	850 nm / 18 mW/sr
VSMY5890	-	890 nm / 18 mW/sr
VSMY5890X01	-	890 nm / 18 mW/sr
VSMY5940	-	940 nm / 18 mW/sr
VSMY5940X01	-	940 nm / 18 mW/sr
VSMY7850X01	-	850 nm / 390 mW/sr
VSMY7852X01	-	850 nm / 90 mW/sr
VSMY98145DS	-	810 nm / 800 mW/sr
VSMY98525DS	-	850 nm / 1600 mW/sr
VSMY98545	-	850 nm / 550 mW/sr
VSMY98545ADS	-	850 nm / 1000 mW/sr
VSMY98545DS	-	850 nm / 900 mW/sr
VSMY9857535	-	850 nm / 290 mW/sr
VSMY98575ADS	-	850 nm / 500 mW/sr
VSMY99445DS	-	940 nm / 900 mW/sr
VCNL3020	-	890 nm / 10 mW/sr
VCNL4020	-	890 nm / 10 mW/sr
VCNL4100	-	940 nm / 100 mW/sr
VCNL4200	-	940 nm / 100 mW/sr

Note

- All listed diode emitters are inside exempt group of IEC 62471



IEC 62471 AND EU DIRECTIVE 2006/25/EC

For all applications the standard IEC 62471 is applicable.

This standard for incoherent sources replaces for LEDs the laser standard IEC DIN EN 60825-1.

In case of IR - Emitters the dominating limit is the cornea/lens risk in the wavelength range from 780 nm to 3000 nm. This limits the irradiance to $E_e = 100 \text{ W/m}^2$ which is expressed as intensity a value of $I_e = 4 \text{ W/sr}$ with the measurement condition of that standard with 0.2 m distance in mind ($I_e = E_e \times r^2$).

Evaluating the other limiting conditions as the thermal retinal risk and blue light hazard result in not limiting higher values for wavelengths $\lambda > 850 \text{ nm}$ and therefore are not to be taken into account. Only for $\lambda = 830 \text{ nm}$ a little reduction to $I_e = 3.77 \text{ W/sr}$ is given by the thermal risk.

This is still far above of the emitted intensities of IREDS covered by the Vishay datasheets.



Disclaimer

ALL PRODUCT, PRODUCT SPECIFICATIONS AND DATA ARE SUBJECT TO CHANGE WITHOUT NOTICE TO IMPROVE RELIABILITY, FUNCTION OR DESIGN OR OTHERWISE.

Vishay Intertechnology, Inc., its affiliates, agents, and employees, and all persons acting on its or their behalf (collectively, "Vishay"), disclaim any and all liability for any errors, inaccuracies or incompleteness contained in any datasheet or in any other disclosure relating to any product.

Vishay makes no warranty, representation or guarantee regarding the suitability of the products for any particular purpose or the continuing production of any product. To the maximum extent permitted by applicable law, Vishay disclaims (i) any and all liability arising out of the application or use of any product, (ii) any and all liability, including without limitation special, consequential or incidental damages, and (iii) any and all implied warranties, including warranties of fitness for particular purpose, non-infringement and merchantability.

Statements regarding the suitability of products for certain types of applications are based on Vishay's knowledge of typical requirements that are often placed on Vishay products in generic applications. Such statements are not binding statements about the suitability of products for a particular application. It is the customer's responsibility to validate that a particular product with the properties described in the product specification is suitable for use in a particular application. Parameters provided in datasheets and / or specifications may vary in different applications and performance may vary over time. All operating parameters, including typical parameters, must be validated for each customer application by the customer's technical experts. Product specifications do not expand or otherwise modify Vishay's terms and conditions of purchase, including but not limited to the warranty expressed therein.

Hyperlinks included in this datasheet may direct users to third-party websites. These links are provided as a convenience and for informational purposes only. Inclusion of these hyperlinks does not constitute an endorsement or an approval by Vishay of any of the products, services or opinions of the corporation, organization or individual associated with the third-party website. Vishay disclaims any and all liability and bears no responsibility for the accuracy, legality or content of the third-party website or for that of subsequent links.

Except as expressly indicated in writing, Vishay products are not designed for use in medical, life-saving, or life-sustaining applications or for any other application in which the failure of the Vishay product could result in personal injury or death. Customers using or selling Vishay products not expressly indicated for use in such applications do so at their own risk. Please contact authorized Vishay personnel to obtain written terms and conditions regarding products designed for such applications.

No license, express or implied, by estoppel or otherwise, to any intellectual property rights is granted by this document or by any conduct of Vishay. Product names and markings noted herein may be trademarks of their respective owners.