

Features:

- 1200V Field Stop Trench Technology
- High Speed Switching
- Low Conduction Loss
- Positive Temperature Coefficient
- Easy parallel Operation
- RoHS compliant
- JEDEC Qualification

Applications :

Induction Heating, Soft switching application, UPS, Welder, Inverter

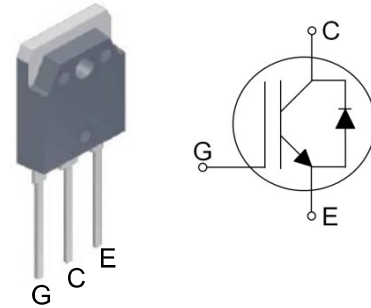

Device	Package	Marking	Remark
GPA040A120MN-FD	TO-3PN	GPA040A120MN-FD	RoHS

Absolute Maximum Ratings

Parameter	Symbol	Value	Unit
Collector-Emitter Voltage	V_{CES}	1200	V
Gate-Emitter Voltage	V_{GES}	± 20	V
Continuous Collector Current	I_c	$T_C = 25\text{ }^\circ\text{C}$	80
		$T_C = 100\text{ }^\circ\text{C}$	40
Pulsed Collector Current (Note 1)	I_{CM}	120	A
Diode Continuous Forward Current	I_F	40	A
Diode Maximum Forward Current	I_{FM}	120	A
Power Dissipation	P_D	$T_C = 25\text{ }^\circ\text{C}$	480
		$T_C = 100\text{ }^\circ\text{C}$	192
Operating Junction Temperature	T_J	-55 ~ 150	$^\circ\text{C}$
Storage Temperature Range	T_{STG}	-55 ~ 150	$^\circ\text{C}$
Maximum lead temperature for soldering purposes, 1/8" from case for 5 seconds	T_L	300	$^\circ\text{C}$

Notes :

(1) Repetitive rating : Pulse width limited by maximum junction temperature

Thermal Characteristics

Parameter	Symbol	Value	Unit
Maximum Thermal resistance, Junction-to-Case	$R_{\theta JC}$ (IGBT)	0.26	$^\circ\text{C}/\text{W}$
Maximum Thermal resistance, Junction-to-Case	$R_{\theta JC}$ (DIODE)	0.95	$^\circ\text{C}/\text{W}$
Maximum Thermal resistance, Junction-to-Ambient	$R_{\theta JA}$	40	$^\circ\text{C}/\text{W}$

Electrical Characteristics of the IGBT $T_C=25^\circ\text{C}$, unless otherwise noted

Parameter	Symbol	Test condition	Min.	Typ.	Max.	Unit
OFF						
Collector – Emitter Breakdown Voltage	BV_{CES}	$V_{GE} = 0V, I_C = 1mA$	1200	--	--	V
Zero Gate Voltage Collector Current	I_{CES}	$V_{CE} = 1200V, V_{GE} = 0V$	--	--	1	mA
Gate – Emitter Leakage Current	I_{GES}	$V_{CE} = 0V, V_{GE} = \pm 20V$	--	--	± 250	nA
ON						
Gate – Emitter Threshold Voltage	$V_{GE(TH)}$	$V_{GE} = V_{CE}, I_C = 40mA$	4.5	6.5	8.5	V
Collector – Emitter Saturation Voltage	$V_{CE(SAT)}$	$V_{GE} = 15V, I_C = 40A, T_C = 25^\circ\text{C}$	--	2.0	2.6	V
		$V_{GE} = 15V, I_C = 40A, T_C = 125^\circ\text{C}$	--	2.45	--	V
DYNAMIC						
Input Capacitance	C_{IES}	$V_{CE} = 30V,$ $V_{GE} = 0V$ $f = 1MHz$	--	5150	--	pF
Output Capacitance	C_{OES}		--	150	--	pF
Reverse Transfer Capacitance	C_{RES}		--	100	--	pF
SWITCHING (Note 2)						
Turn-On Delay Time	$t_{d(on)}$	$V_{CC} = 600V, I_C = 40A$ $R_G = 5\Omega, V_{GE} = 15V$ Inductive Load, $T_C = 25^\circ\text{C}$	--	55	--	ns
Rise Time	t_r		--	80	--	ns
Turn-Off Delay Time	$t_{d(off)}$		--	200	--	ns
Fall Time	t_f		--	55	110	ns
Turn-On Switching Loss	E_{ON}		--	5.3	8.0	mJ
Turn-Off Switching Loss	E_{OFF}		--	1.1	1.6	mJ
Total Switching Loss	E_{TS}		--	6.4	9.6	mJ
Turn-On Delay Time	$t_{d(on)}$	$V_{CC} = 600V, I_C = 40A$ $R_G = 5\Omega, V_{GE} = 15V$ Inductive Load, $T_C = 125^\circ\text{C}$	--	45	--	ns
Rise Time	t_r		--	75	--	ns
Turn-Off Delay Time	$t_{d(off)}$		--	210	--	ns
Fall Time	t_f		--	115	--	ns
Turn-On Switching Loss	E_{ON}		--	5.6	8.4	mJ
Turn-Off Switching Loss	E_{OFF}		--	2.2	3.3	mJ
Total Switching Loss	E_{TS}		--	7.8	11.7	mJ
Total Gate Charge	Q_g	$V_{CC} = 600V, I_C = 40A$ $V_{GE} = 15V$	--	320	480	nC
Gate-Emitter Charge	Q_{ge}		--	40	60	nC
Gate-Collector Charge	Q_{gc}		--	150	225	nC

Notes :

(2) Not subject to production test – verified by design/characterization

Electrical Characteristics of the DIODE $T_C=25^{\circ}\text{C}$, unless otherwise noted

Parameter	Symbol	Test condition	Min.	Typ.	Max.	Unit	
Diode Forward Voltage	V_{FM}	$I_F = 40\text{A}$	$T_C = 25^{\circ}\text{C}$	--	2.85	--	V
			$T_C = 125^{\circ}\text{C}$	--	2.9	--	
Reverse Recovery Time	t_{rr}	$I_F = 40\text{A},$ $di/dt = 200\text{A}/\mu\text{s}$	$T_C = 25^{\circ}\text{C}$	--	200	--	ns
			$T_C = 125^{\circ}\text{C}$	--	325	--	
Reverse Recovery Current	I_{rr}		$T_C = 25^{\circ}\text{C}$	--	23	--	A
			$T_C = 125^{\circ}\text{C}$	--	43	--	
Reverse Recovery Charge	Q_{rr}		$T_C = 25^{\circ}\text{C}$	--	2500	--	nC
			$T_C = 125^{\circ}\text{C}$	--	7000	--	

IGBT Characteristics

Fig. 1 Output characteristics

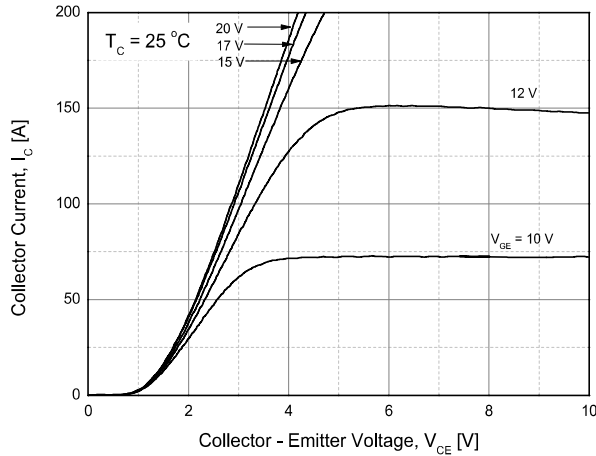

Fig. 2 Saturation voltage characteristics

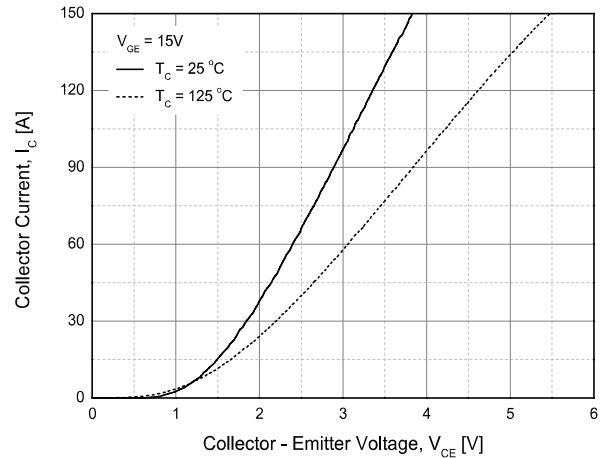

Fig. 3 Saturation voltage vs. collector current

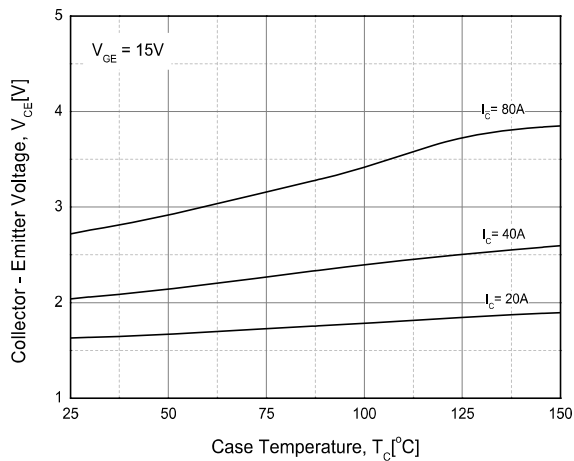

Fig. 4 Saturation voltage vs. gate bias

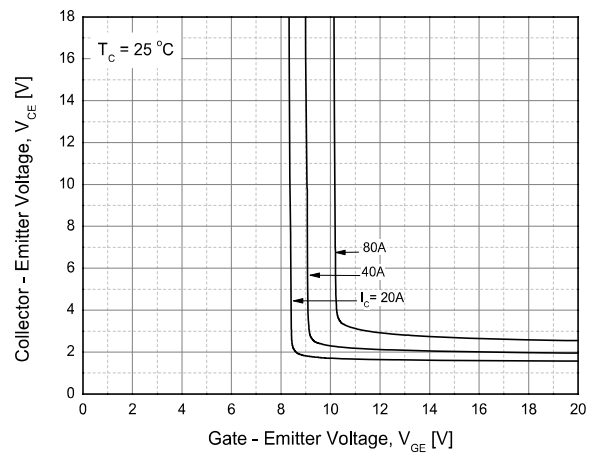

Fig. 5 Saturation voltage vs. gate bias

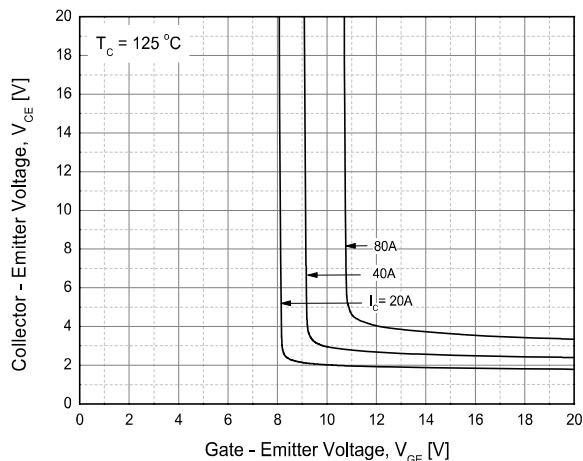
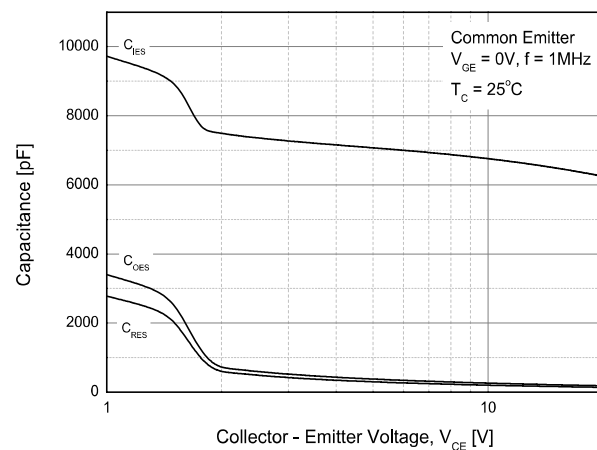

Fig. 6 Capacitance characteristics



IGBT Characteristics

Fig. 7 Turn-on time vs. gate resistor

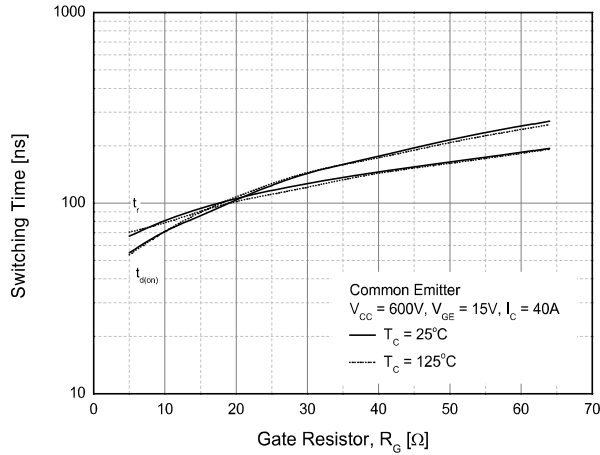

Fig. 8 Turn-off time vs. gate resistor

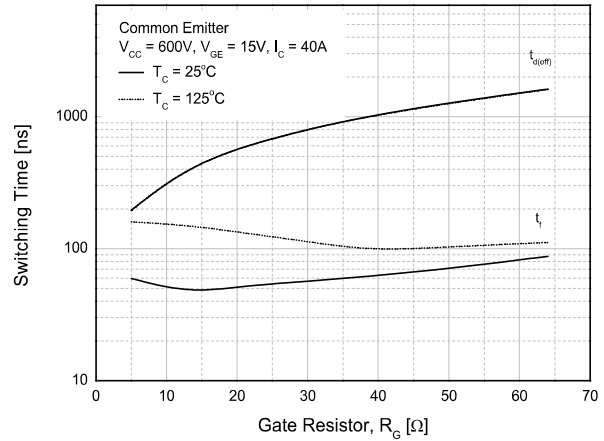

Fig. 9 Switching loss vs. gate resistor

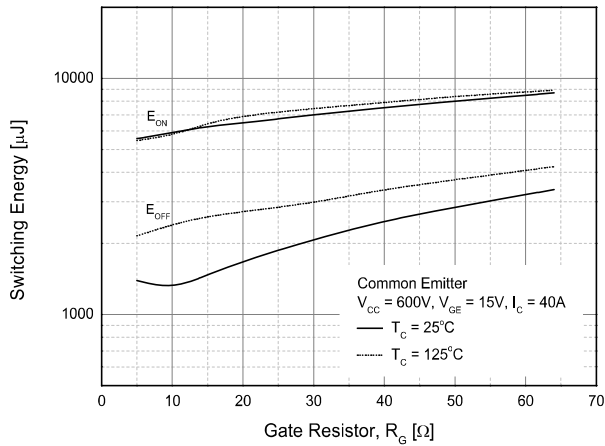

Fig. 10 Turn-on time vs. collector current

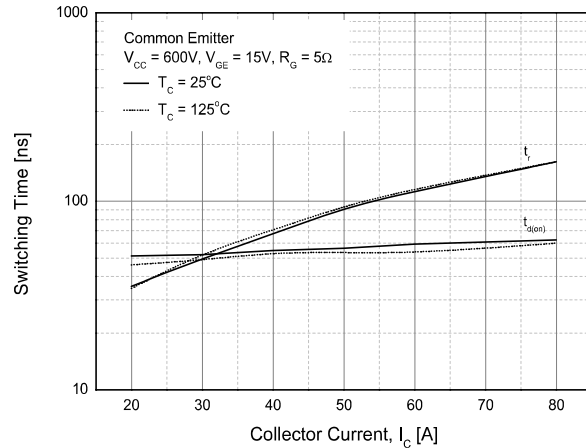

Fig. 11 Turn-off time vs. collector current

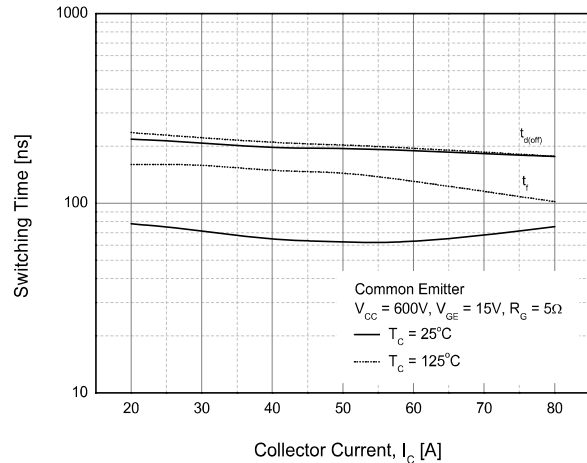
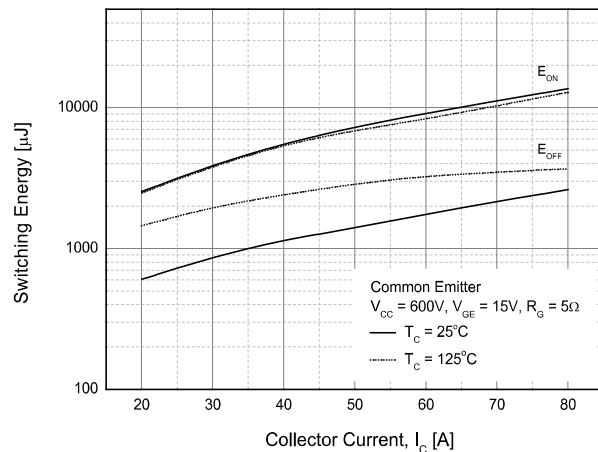

Fig. 12 Switching loss vs. collector current



IGBT Characteristics

Fig. 13 Gate charge characteristics

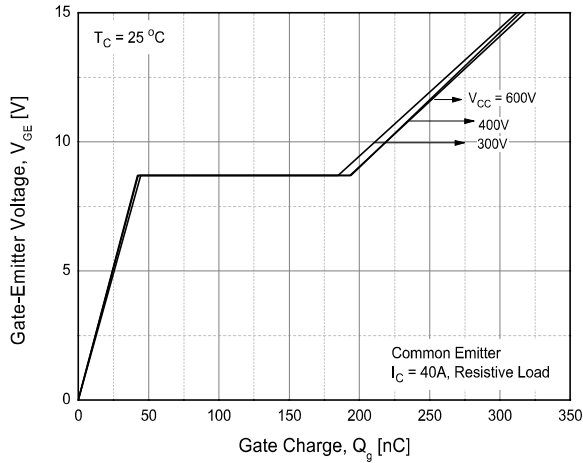

Fig. 14 SOA

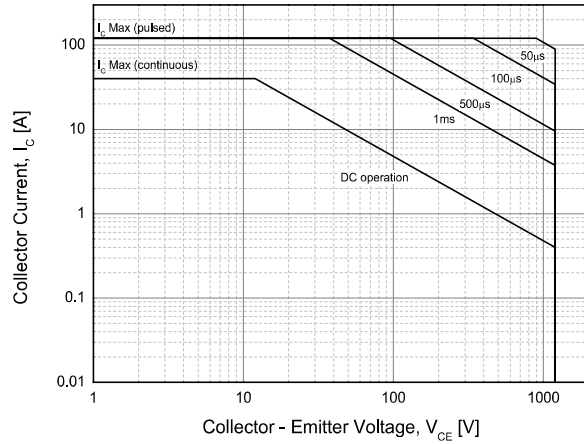

Fig. 15 RBSOA

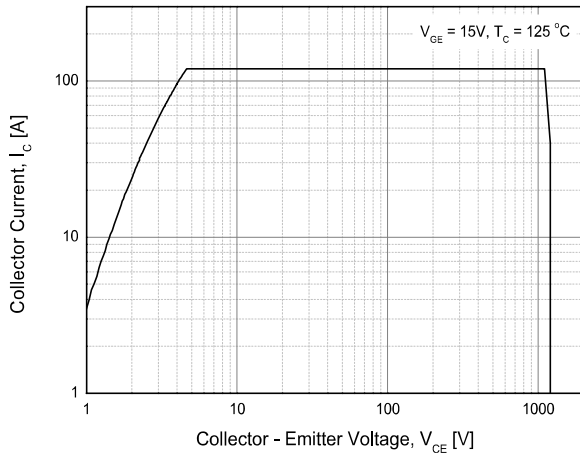

Fig. 16 Transient thermal impedance of IGBT

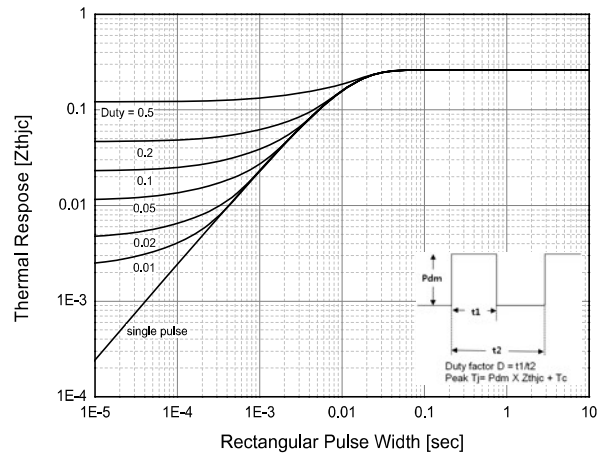
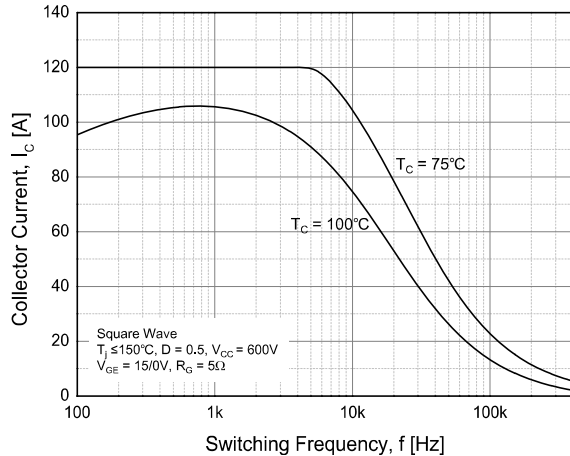

Fig. 17 Load Current vs. Frequency



Diode Characteristics

Fig. 18 Conduction characteristics

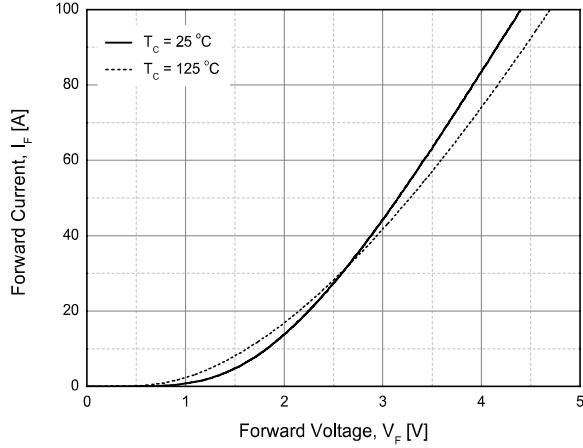

Fig. 19 Reverse recovery current vs. forward current

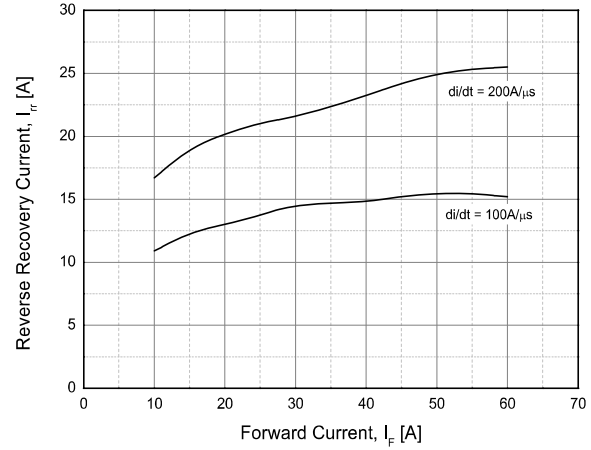

Fig. 20 Reverse recovery charge vs. forward current

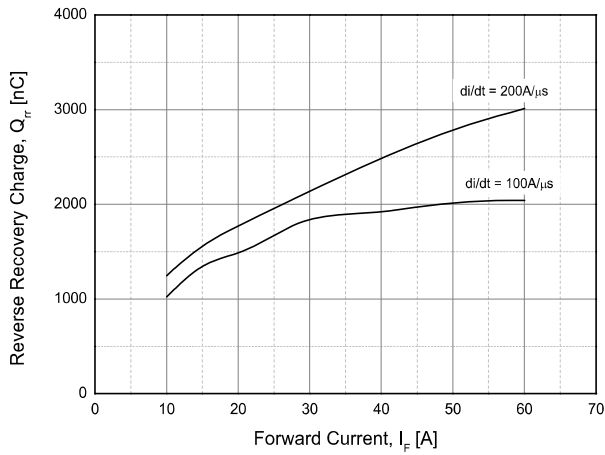
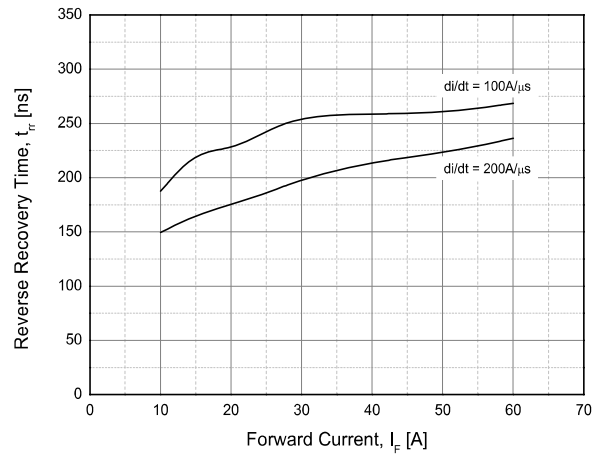
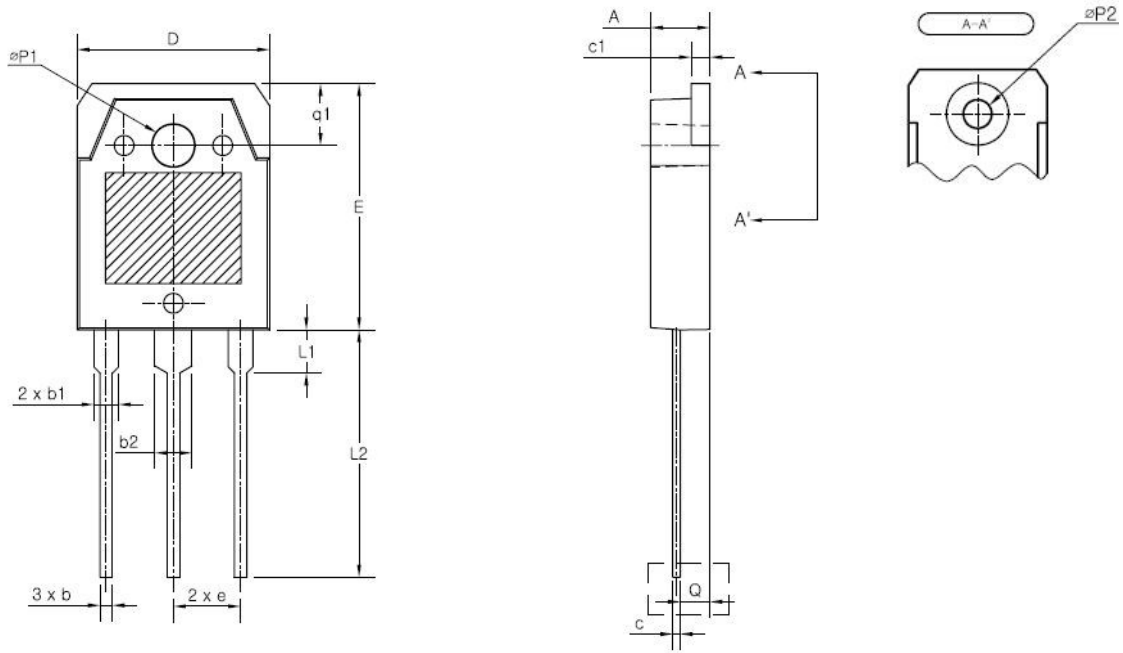

Fig. 21 Reverse recovery time vs. forward current



TO-3PN MECHANICAL DATA



SYMBOL	MIN	NOM	MAX
A	4.60	4.80	5.00
b	0.80	1.00	1.20
b1	1.80	2.00	2.20
b2	2.80	3.00	3.20
c	0.55	0.60	0.75
c1	1.45	1.50	1.65
D	15.40	15.60	15.80
E	19.70	19.90	20.10
e	5.15	5.45	5.75
L1	3.30	3.50	3.70
L2	19.80	20.00	20.20
øP1	3.30	3.40	3.50
øP2	(3.20)		
Q	2.20	2.40	2.60
q1	4.80	5.00	5.20

Notes

- **RoHS Compliance**

The levels of RoHS restricted materials in this product are below the maximum concentration values (also referred to as the threshold limits) permitted for such substances, or are used in an exempted application, in accordance with EU Directive 2011/65/EC (RoHS2), as implemented March, 2013. RoHS Declarations for this product can be obtained from the Product Documentation sections of www.gptechgroup.com.

- **REACH Compliance**

REACH substances of high concern (SVHCs) information is available for this product. Since the European Chemical Agency (ECHA) has published notice of their intent to frequently revise the SVHC listing for the foreseeable future, please contact our office at GPTG Headquarters in Lake Forest, California to insure you get the most up-to-date REACH SVHC Declaration.

REACH banned substance information (REACH Article 67) is also available upon request.

- This product has not been designed or tested for use in, and is not intended for use in, applications implanted into the human body nor in applications in which failure of the product could lead to death, personal injury or property damage, including but not limited to equipment used in the operation of nuclear facilities, life-support machines, cardiac defibrillators or similar emergency medical equipment, aircraft navigation or communication or control systems, or air traffic control.

- To obtain additional technical information or to place an order for this product, please contact us. The information in this datasheet is provided by Global Power Technologies Group. GPTG reserves the right to make changes, corrections, modifications, and improvements of datasheet without notice.

Global Power Technologies Group

20692 Prism Place

Lake Forest, CA 92630

TEL (949) 207-7500

FAX (949) 613-7600

E-mail: info@gptechgroup.com

Web site: www.gptechgroup.com

