



SPECIFICATION SHEET

SPECIFICATION SHEET NO.	N0521-SA315M0000S001
DATE	May 21, 2021
REVISION	A0
DESCRIPTION	SMD SAW Resonator 5050 Type L5.0*W5.0*H1.35mm 8 Pads S3 Series 315.000KHz, Insertion Loss: 2.2 dB Max. Tolerance: +/-75KHz Operating Temp. Range -40°C ~+85°C Reflow Profile Condition 260 °C Max. Tape/Reel, RoHS/RoHS III compliant
CUSTOMER	
CUSTOMER PART NUMBER	
CROSS REF. PART NUMBER	
ORIGINAL PART NUMBER	TGS SR 315.0MA S3 TLF
PART CODE	SA315M0000S001

VENDOR APPROVE			
Issued/Checked/Approved			
DATE: May 21, 2021			

CUSTOMER APPROVE	
DATE:	

SMD SAW RESONATOR 5050 TYPE S3 SERIES

MAIN FEATURE

- SMD SAW Resonator 5050 Type 8 Pads
- Dimension L5.0*W5.0*H1.35mm
- Reflow Profile Condition 260 °C Max.
- Cross more competitors part
- RoHS/RoHS III compliant



APPLICATION

- Bluetooth, wireless communication set
- Communication Electronics

RFQ
[Request For Quotation](#)

PART CODE GUIDE

SA	315M0000	S	001
1	2	3	4

- 1) SA: Part family Code for SMD SAW Resonator 5050 Type L5.0*W5.0*H1.35mm 8 Pads S3 Series
- 2) 315M0000: Frequency range code for 315.000MHz
- 3) S: SMD type, Package Tape/Reel, 1000pcs/Reel
- 4) 001: Specification code for original part No.: **TGS SR 315.0MA S3 TLF**

MORE FREQUENCY RANGE AVAILABLE (MHz)

315.00	340.000								

SMD SAW RESONATOR 5050 TYPE S3 SERIES

DIMENSION (Unit: mm, Tol. +/-0.15mm)

Image for reference

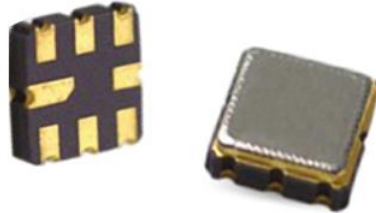

S3

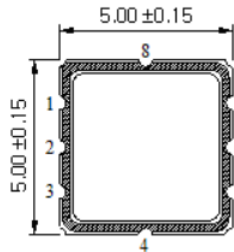

Marking
Frequency Range

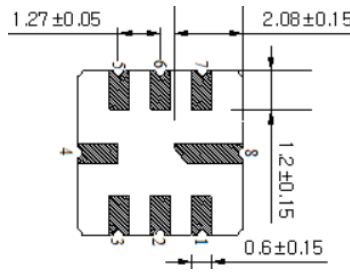

Connection
Pin 2: Input
Pin 6: Output
Other pins: Ground



Measuring Circuit

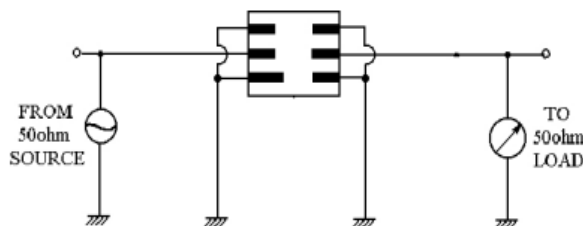

Note:
Test Temperature: 25 °C±2 °C
Terminating Source Impedance: 50Ω
Termination Load Impedance: 50Ω

SMD SAW RESONATOR 5050 TYPE S3 SERIES
ELECTRICAL PARAMETERS

Parameter		Part No. Symbol	Units	Value		
				Min.	Typical	Max.
Original Manufacturer		TGS	TGS Crystals			
Holder Type		SR	SAW Resonator			
Frequency Range (f0)		315.0M	MHz	315.0000		
Frequency Tolerance		A	KHz	-75		+75
Operation Temperance			°C	-40		+85
Storage Temperance			°C	-40		+85
DC Voltage (between any Terminals)			V		5.0	
RF Power (in BW)			dBm		0	
ESD Voltage (HB)			V		400	
Insertion Loss			dB		1.4	2.2
Quality Factor (Q)	Unload				8000	12800
	50 Ω Loaded				1000	2000
Temperature Stability	Turnover Temperature			°C	10	25
	Frequency Temperature Coefficient		ppm/°C		0.032	
Aging			ppm/Year		≤±10	
DC Insulation Resistance			MΩ	1.0		
Transduce Static Capacitance			pF		2.13	
Hold Type		S3		5050 Type 8 Pads L5.0*W5.0*H1.35mm		
Other	Package	T	Tape/Reel, 1000pcs/Reel			
	RoHS Status	LF	RoHS III compliant			
	Add Value		Blank: N/A			
	Internal Control Code		Blank: N/A			

Note:

Original Part Number: TGS SR 315.0MA S3 TLF

SMD SAW RESONATOR 5050 TYPE S3 SERIES

FREQUENCY RESPONSE

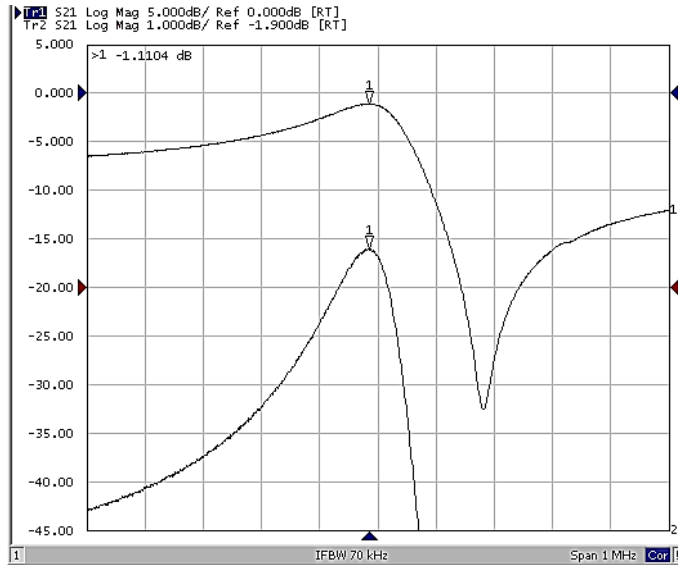

EQUIVALENT LC MODEL

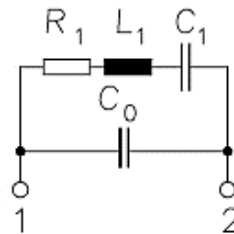

PLICTYPICAL APATION CIRCUITS

Typical Low-power Transmitter Application

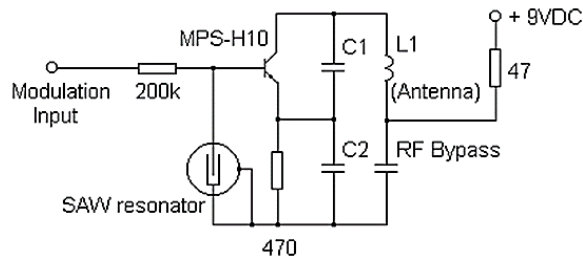

Typical Local Oscillator Application

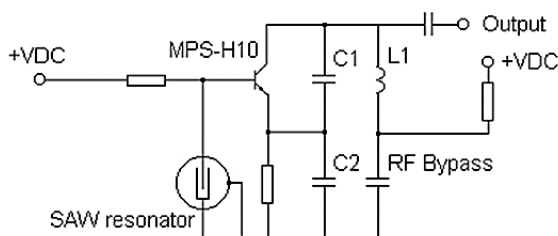

SMD SAW RESONATOR 5050 TYPE S3 SERIES

RELIABILITY

Test Items	Test Method And Conditions	Requirement
Temperature Storage	(1) Temperature: 85°C±2°C , Duration: 250h , Recovery time: 2h±0.5h (2) Temperature: -55°C±3°C , Duration: 250h ,Recovery time: 2h±0.5h	It shall remain electrical performance after tests
Humidity Test	Conditions: 60°C±2°C , 90~95% RH Duration: 250h	
Thermal Shock	Heat cycle conditions: TA=-55°C±3°C, TB=85°C±2°C, t1=t2=30min, Switch time: ≤3min, Cycle time: 100 times, Recovery time: 2h±0.5h.	
Vibration Fatigue	Frequency of vibration: 10~55Hz Amplitude:1.5mm Directions: X,Y and Z Duration: 2h	
Drop Test	Cycle time: 10 times Height: 1.0m	
Solderability	Temperature: 245°C±5°C Duration: 3.0s--5.0s Depth: DIP--2/3 , SMD--1/5	
Resistance to Soldering Heat	(1)Thickness of PCB:1mm , Solder condition: 260°C±5°C , Duration: 10±1s (2)Temperature of Soldering Iron: 350°C±10°C , Duration: 3~4s , Recovery time : 2 ± 0.5h	

SUGGESTED REFLOW PROFILE (For Reference Only)

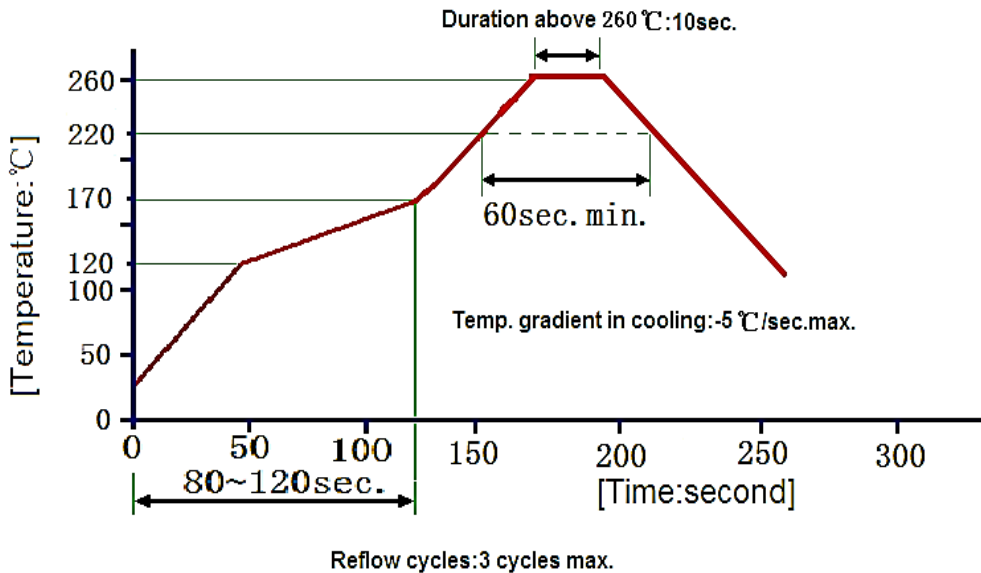

SMD SAW RESONATOR 5050 TYPE S3 SERIES

REEL DIMENSION (Unit: mm, 1000pcs/Reel)

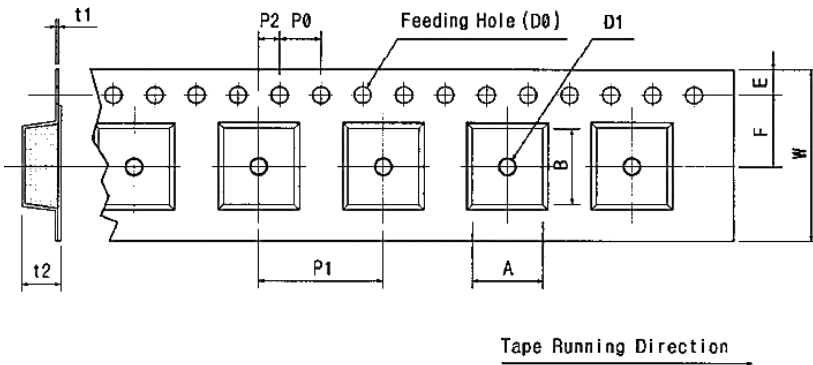

Code	Dimension
W	12.0+/-0.30
F	5.50+/-0.05
E	1.75+/-0.10
P 0	4.00+/-0.10
P 1	8.00+/-0.10
P 2	2.00+/-0.05
D 0	Ø1.5+/-0.10
D 1	Ø1.0+/-0.25
t 1	0.30+/-0.05
t 2	2.10+/-0.10
A	6.40+/-0.10
B	5.20+/-0.10

TAPE WIDE 8MM DIMENSION (Unit: mm)

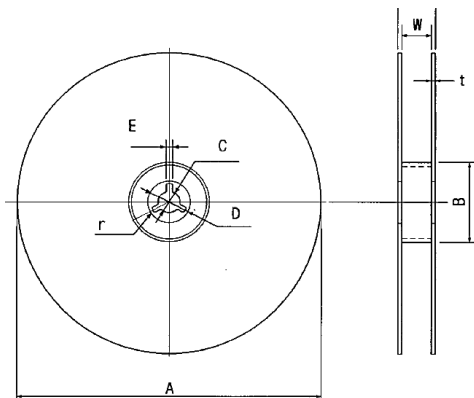

Code	Dimension
A	Ø330+/-1.0
B	Ø100+/-0.5
C	Ø13.0+/-0.5
D	Ø21+/-0.8
E	2.00+/-0.5
W	13.0+/-0.30
t	3.00 Max.
r	1.00 Max.

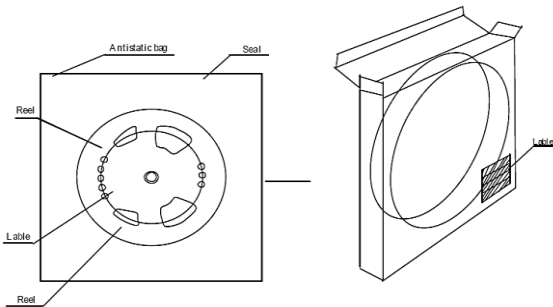

DISCLAIMER

NextGen Components, Inc. reserves the right to make changes to the product(s) and or information contained herein without notice. No liability is assumed as a result of their use or application. No rights under any patent accompany the sale of any such product(s) or information