

Description

The 3415 A uses advanced trench technology to provide excellent $R_{DS(ON)}$, low gate charge and operation with gate voltages as low as 1.8V. This device is suitable for use as a load switch or in PWM applications. It is ESD protected.

General Features

●

V_{DSS}	$R_{DS(ON)}$ @-4.5V(Typ)	$R_{DS(ON)}$ @-2.5V(Typ)	I_D
-20V	37 mΩ	50 mΩ	-4.6A

- High Power and current handing capability
- RoHS Compliant
- Surface mount package
- ESD (HBM)>7.0KV

Application

- PWM application
- Load switch

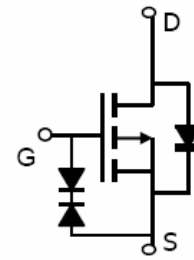

Schematic diagram

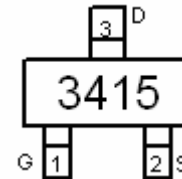

Marking and pin Assignment



SOT-23

Ordering Information

Part Number	Marking	Case	Packaging
3415A	3415	SOT-23	3000pcs/Reel

Absolute Maximum Ratings (TA=25°C unless otherwise noted)

Parameter	Symbol	Limit	Unit
Drain-Source Voltage	V_{DS}	-20	V
Gate-Source Voltage	V_{GS}	±10	V
Drain Current-Continuous	I_D	-4.6	A
Drain Current-Pulsed (Note 1)	I_{DM}	-16	A
Maximum Power Dissipation	P_D	1.4	W
Operating Junction and Storage Temperature Range	T_J, T_{STG}	-55 To 150	°C

Thermal Characteristic

Thermal Resistance, Junction-to-Ambient (Note 2)	$R_{θJA}$	89.3	°C/W
--	-----------	------	------

Electrical Characteristics (TA=25°C unless otherwise noted)

Parameter	Symbol	Condition	Min	Typ	Max	Unit
Off Characteristics						
Drain-Source Breakdown Voltage	BV_{DSS}	$V_{GS}=0V, I_D=-250\mu A$	-20		-	V

Zero Gate Voltage Drain Current	I_{DSS}	$V_{DS}=-20V, V_{GS}=0V$	-	-	1	μA
Gate-Body Leakage Current	I_{GSS}	$V_{GS}=\pm 10V, V_{DS}=0V$	-	-	± 10	μA
On Characteristics (Note 3)						
Gate Threshold Voltage	$V_{GS(th)}$	$V_{DS}=V_{GS}, I_D=-250\mu A$	-0.35	-0.7	-0.9	V
Drain-Source On-State Resistance	$R_{DS(ON)}$	$V_{GS}=-4.5V, I_D=-4A$	-	37	45	$m\Omega$
		$V_{GS}=-2.5V, I_D=-4A$	-	50	60	$m\Omega$
Forward Transconductance	g_{FS}	$V_{DS}=-5V, I_D=-4A$	8	-	-	S
Dynamic Characteristics (Note4)						
Input Capacitance	C_{iss}	$V_{DS}=-10V, V_{GS}=0V,$ $F=1.0MHz$	-	950	-	PF
Output Capacitance	C_{oss}		-	165	-	PF
Reverse Transfer Capacitance	C_{rss}		-	120	-	PF
Switching Characteristics (Note 4)						
Turn-on Delay Time	$t_{d(on)}$	$V_{DD}=-10V, R_L=2.5\Omega$ $V_{GS}=-4.5V, R_{GEN}=3\Omega$	-	12	-	nS
Turn-on Rise Time	t_r		-	10	-	nS
Turn-Off Delay Time	$t_{d(off)}$		-	19	-	nS
Turn-Off Fall Time	t_f		-	25	-	nS
Total Gate Charge	Q_g	$V_{DS}=-10V, I_D=-4A,$ $V_{GS}=-4.5V$	-	12	-	nC
Gate-Source Charge	Q_{gs}		-	1.4	-	nC
Gate-Drain Charge	Q_{gd}		-	3.6	-	nC
Drain-Source Diode Characteristics						
Diode Forward Voltage (Note 3)	V_{SD}	$V_{GS}=0V, I_S=-2A$	-	-	-1.2	V
Diode Forward Current (Note 2)	I_S		-	-	-4.6	A

Notes:

1. Repetitive Rating: Pulse width limited by maximum junction temperature.
2. Surface Mounted on FR4 Board, $t \leq 10$ sec.
3. Pulse Test: Pulse Width $\leq 300\mu s$, Duty Cycle $\leq 2\%$.
4. Guaranteed by design, not subject to production

TYPICAL ELECTRICAL AND THERMAL CHARACTERISTICS

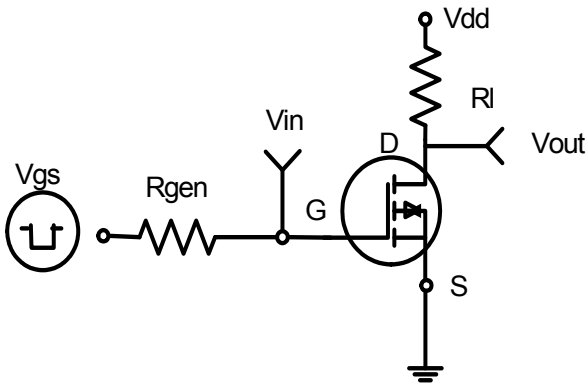

Figure 1: Switching Test Circuit

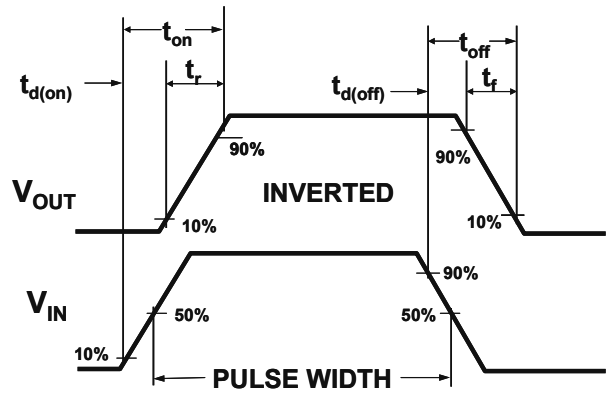

Figure 2: Switching Waveforms

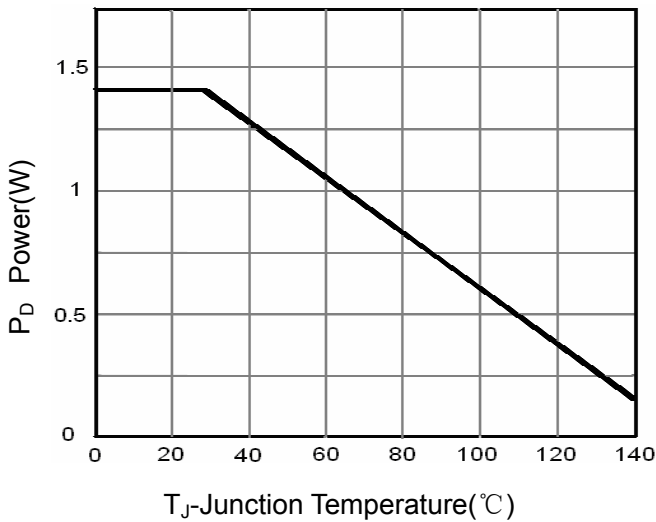

Figure 3 Power Dissipation

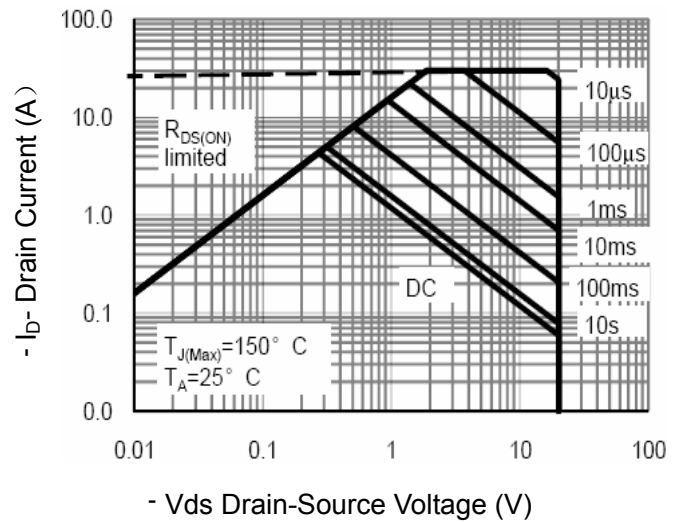

Figure 4 Safe Operation Area

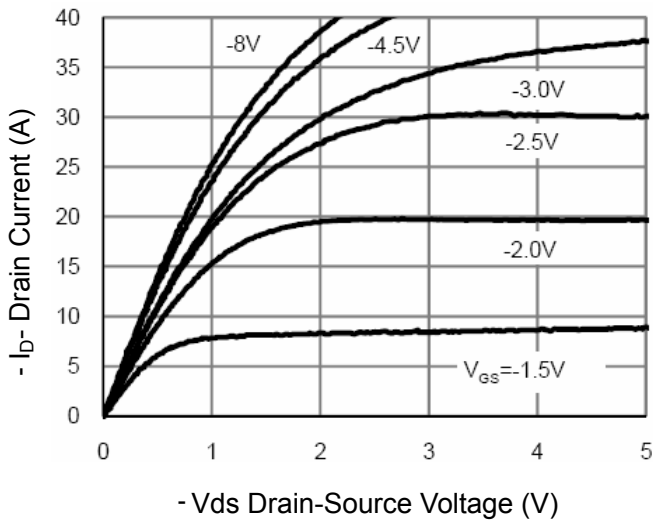

Figure 5 Output CHARACTERISTICS

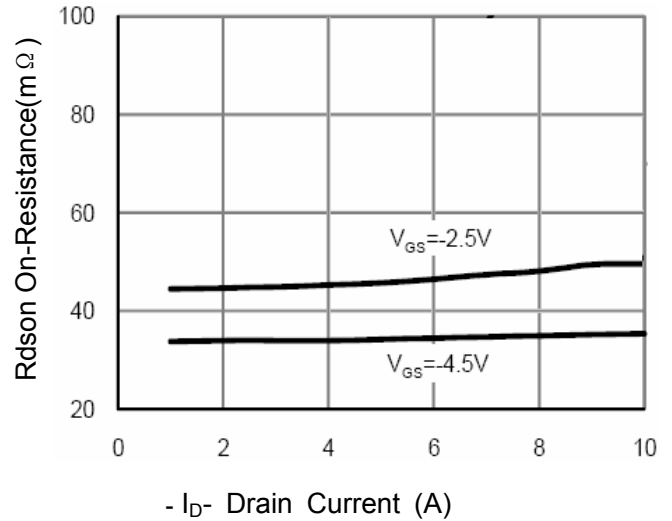

Figure 6 Drain-Source On-Resistance

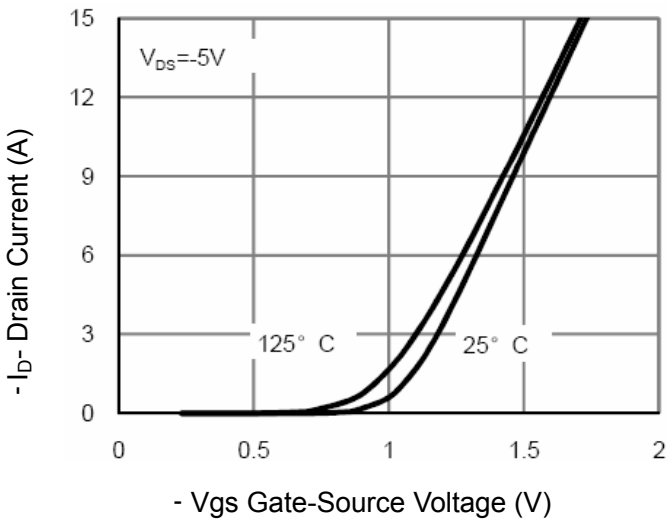

Figure 7 Transfer Characteristics

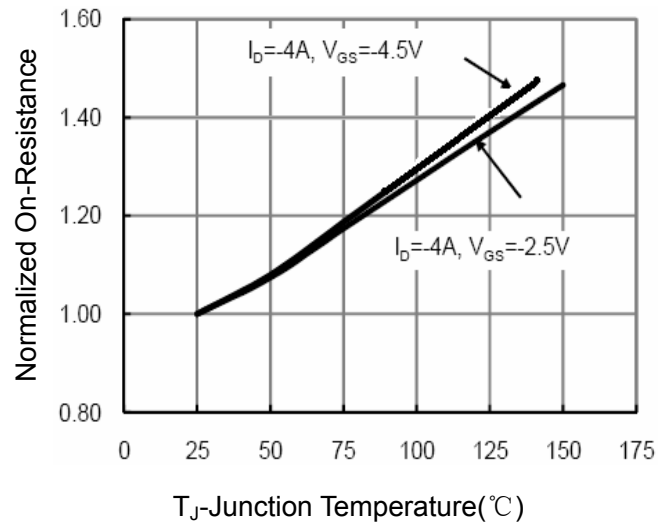

Figure 8 Drain-Source On-Resistance

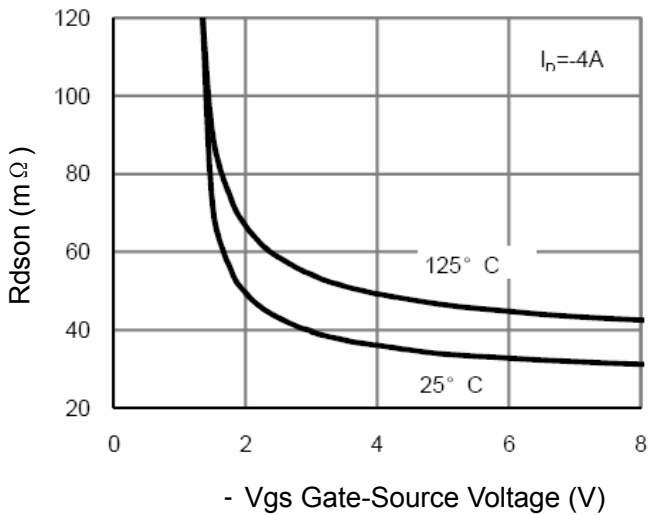

Figure 9 Rdson vs Vgs

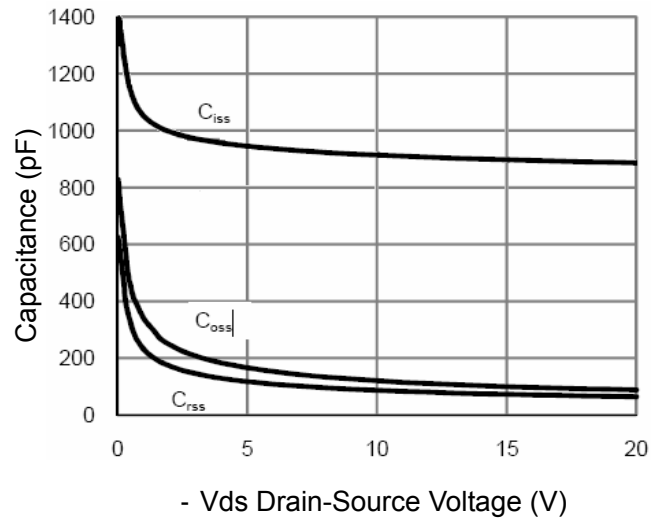

Figure 10 Capacitance vs Vds

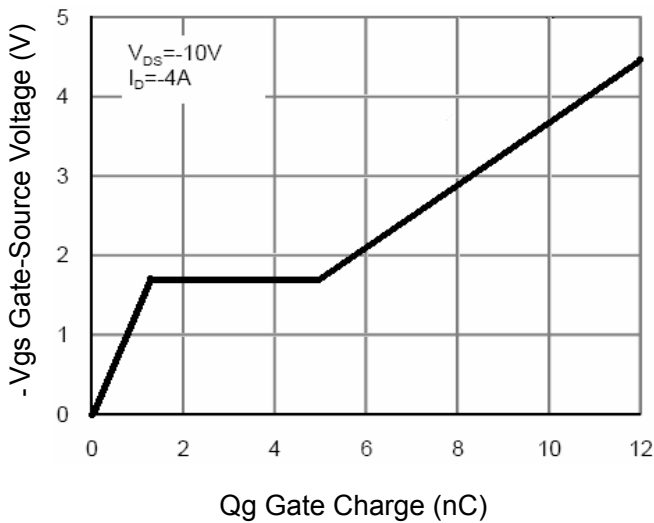

Figure 11 Gate Charge

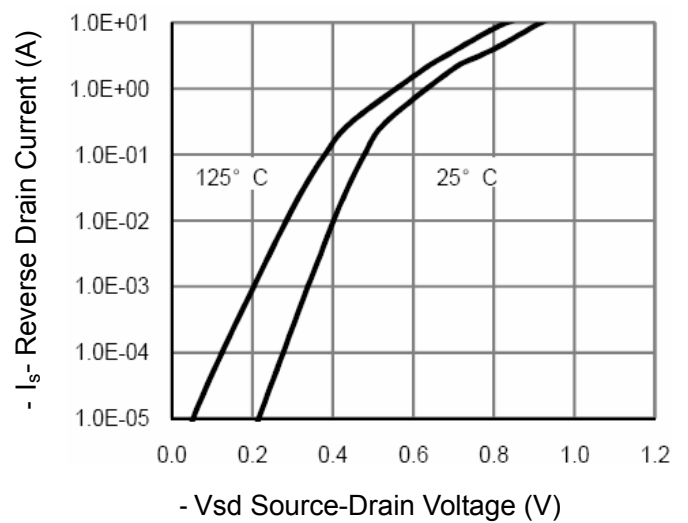

Figure 12 Source- Drain Diode Forward

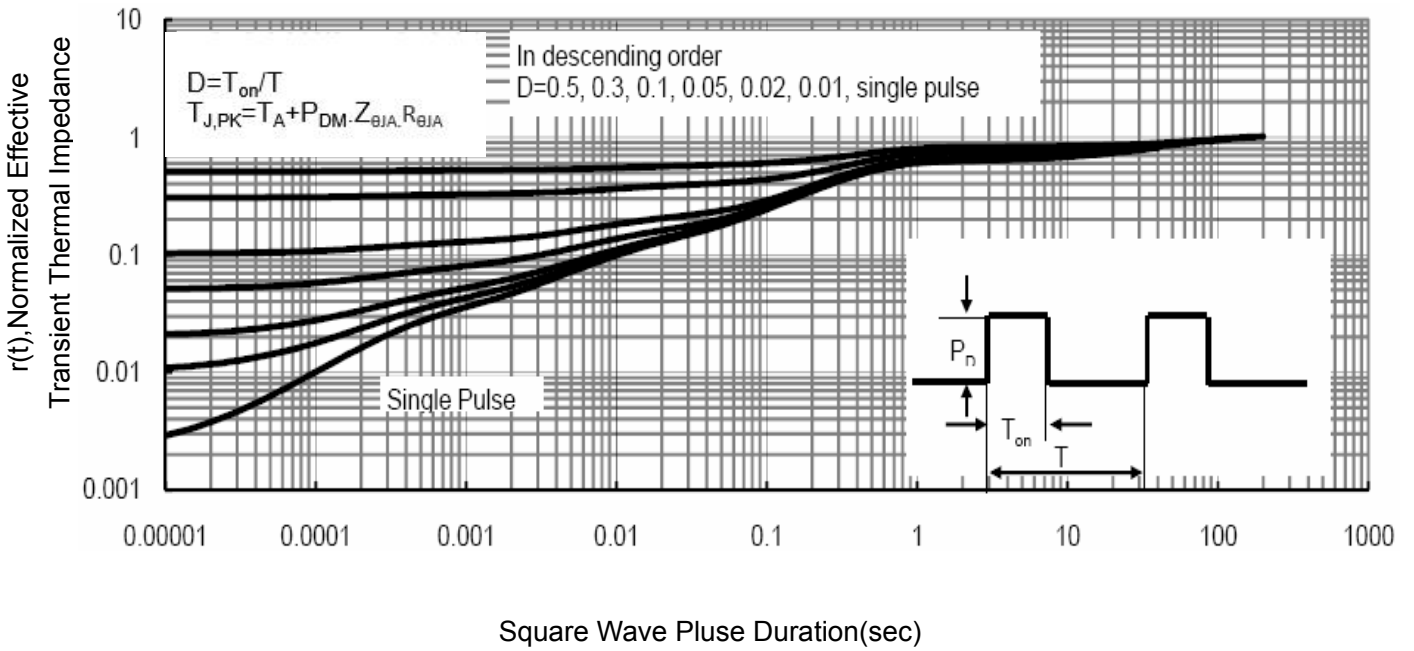
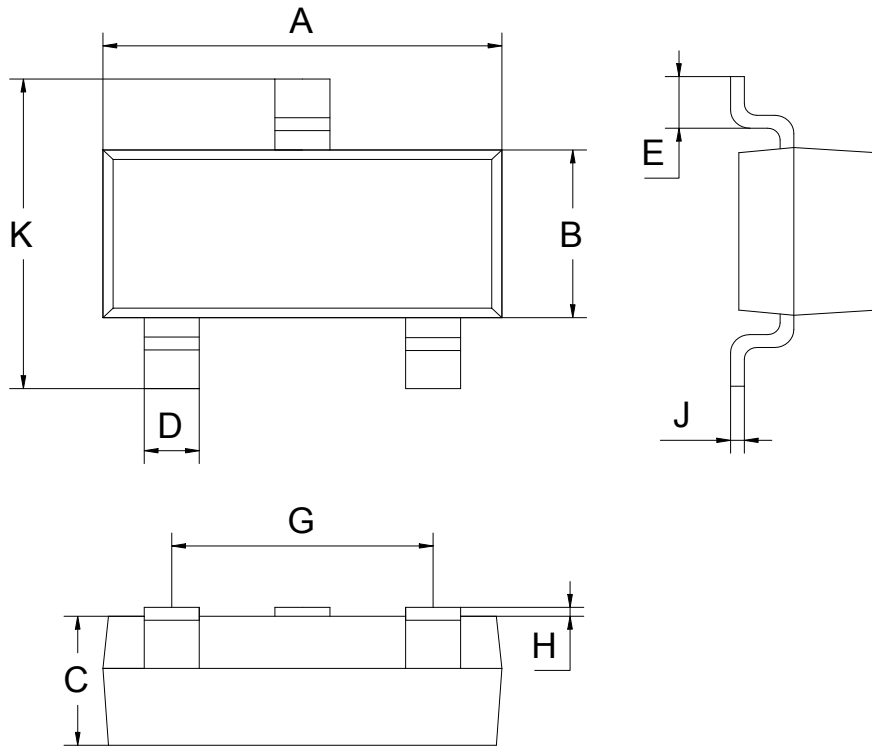

Figure 13 Normalized Maximum Transient Thermal Impedance

SOT-23 Package information



SOT-23			
Dim	MIN	NOM	MAX
A	2.80	2.90	3.00
B	1.20	1.30	1.40
C	0.90	1.00	1.10
D	0.39	0.40	0.45
E	0.20MIN		
G	1.90REF		
H	0.00	-	0.10
J	0.05	0.10	0.15
K	2.30	2.40	2.50
All Dimensions in mm			