

# LED EMP-1040cec-16

**4000K**  
CCT

**90+**  
CRI  
True  
COLOR

**JA8**  
COMPLIANT



## Product Description

LED EMP-1040cec-16 made for seamless light output and hassle-free installation, LED modules are perfect for new or existing light fixtures. Once your existing incandescent, fluorescent or LED-integrated light fixture burns out, simply retrofit this MPLR (multi-purpose LED retrofit) into the fixture's housing. By offering easy, toolless installation, installing this LED module is as simple as screwing in a light bulb. Installing this MPLR eliminates the chore of replacing existing LED fixtures and retrofits incandescent fixtures while reducing unsightly hot spots. For optimal light output, Euri Lighting recommends retrofitting fixtures 16" or less in diameter.



**Estimated Energy Cost:** \$1.92 per year

\*Note: Design, features and specifications subject to change without notice. Some features may not be available on all models. For more information regarding dimmer compatibility please visit: [www.eurilighting.com](http://www.eurilighting.com) or call 1-888-743-5766

## Specifications

Input Power	Input Voltage	Lumen Output	Beam Angle	Center Beam	CCT
16 W	120V/60Hz	1160 lm	180°	N/A	4000 K
CRI	Luminous Efficacy	Power Factor	Input Current	Base/Cap	Lamp Lifespan
90	73 lm/W	0.9	0.13 A	Connector Base	50,000 Hrs.

### Product Features

- Dimmable
- Instant-On/Off
- Mercury Free
- Damp Rated

### Product Dimensions

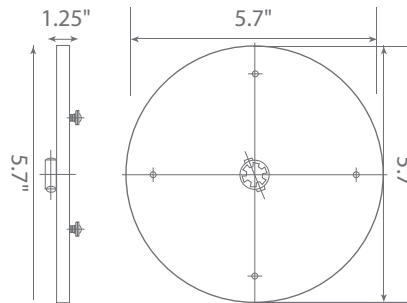

### Product Photometric Data

