

CSRS065V0-G/CSRS045V0-G/CSRS085V0-G

Working Voltage: 5Volts

RoHS Device

Features

- Fast Reverse Recovery Time.
- Fast Turn on Time.
- Low Capacitance SMD Packages.
- 16kV IEC61000-4-2 capable.



Mechanical Data

- Case: SOT-23-6 for CSRS065V0-G,
- SOT-143 for CSRS045V0-G,
- SOIC-8 for CSRS085V0-G.

Circuit Diagram

CSRS065V0-G CSRS045V0-G CSRS085V0-G

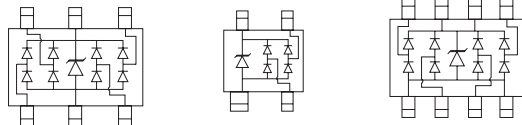

Applications

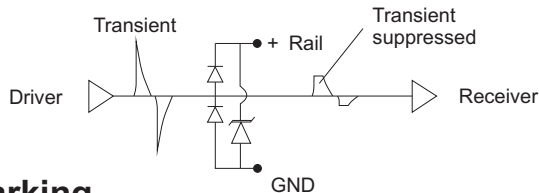

Marking

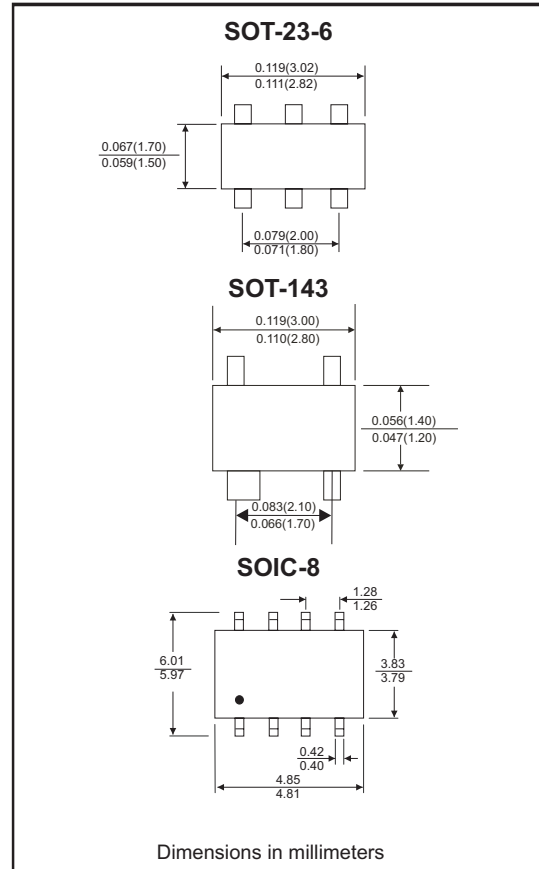
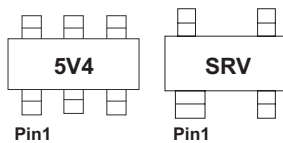

Maximum Rating (at TA=25°C unless otherwise noted)

Parameter	Symbol	Value	Unit
Operating temperature	T _J	-55 to +150	°C

Electrical Characteristics (at TA=25°C unless otherwise noted)

Parameter	Conditions	Symbol	Min.	Max.	Unit
Forward voltage	I _F =50mA	V _F		1.2	V
Reverse stand-off voltage		V _{RWM}		5	V
Diode breakdown voltage	I _R =1μA	V _{BD}	6		V
Reverse leakage current	V _{RWM} =5V	I _R		5	μA
Junction capacitance	f=1MHz, V _R =0V, Line to ground f=1MHz, V _R =0V, Line to Line	C _T		5	pF
ESD capability	IEC 61000-4-2	ESD		16	kV
Peak pulse power	T _P =8/20 μS	PPP		300	W

Rating and Characteristic Curves (CSRS-G Series)

Fig.1 Pulse Power vs. Time

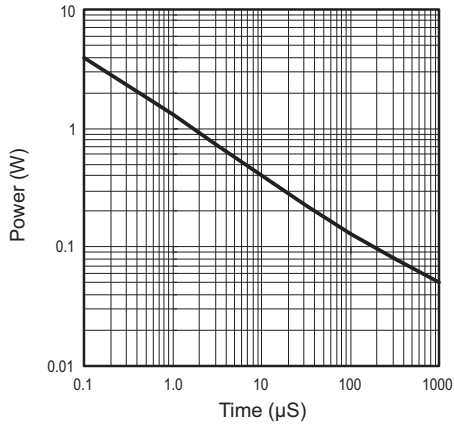

Fig.2 Power Derating

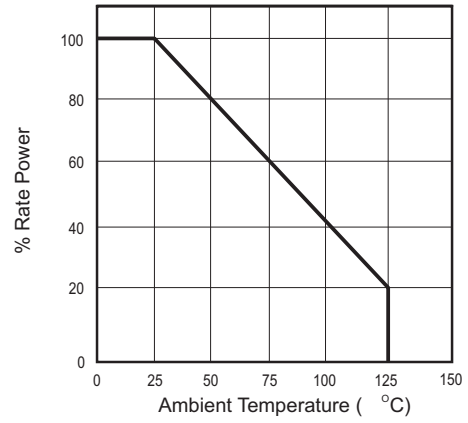

Fig.3 Pulse Waveform

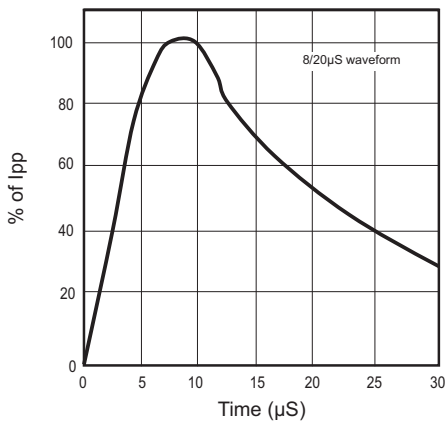

Fig.4 Clamp Voltage vs. Pulse Current

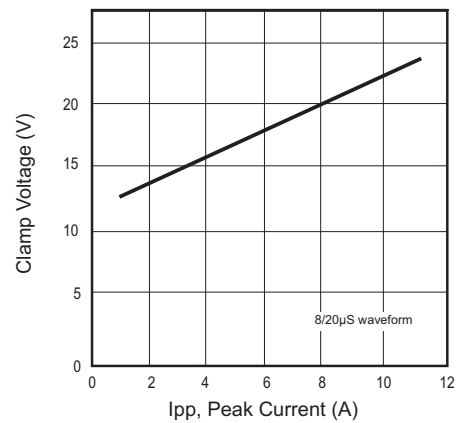

Fig.5 Forward Voltage vs. Forward Current

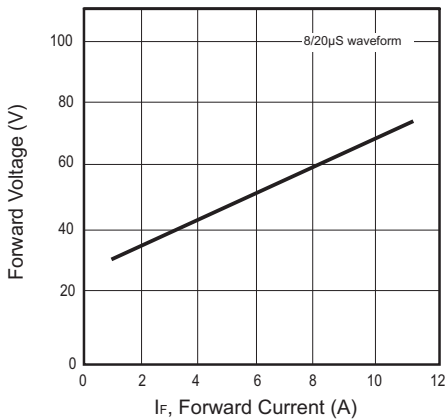
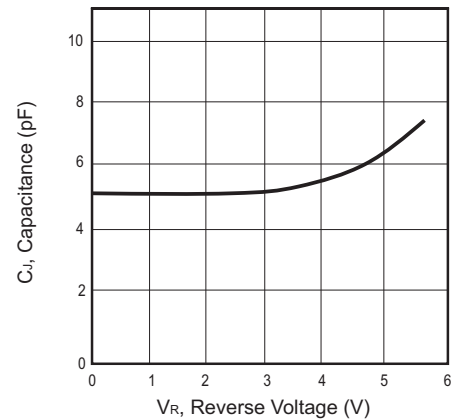
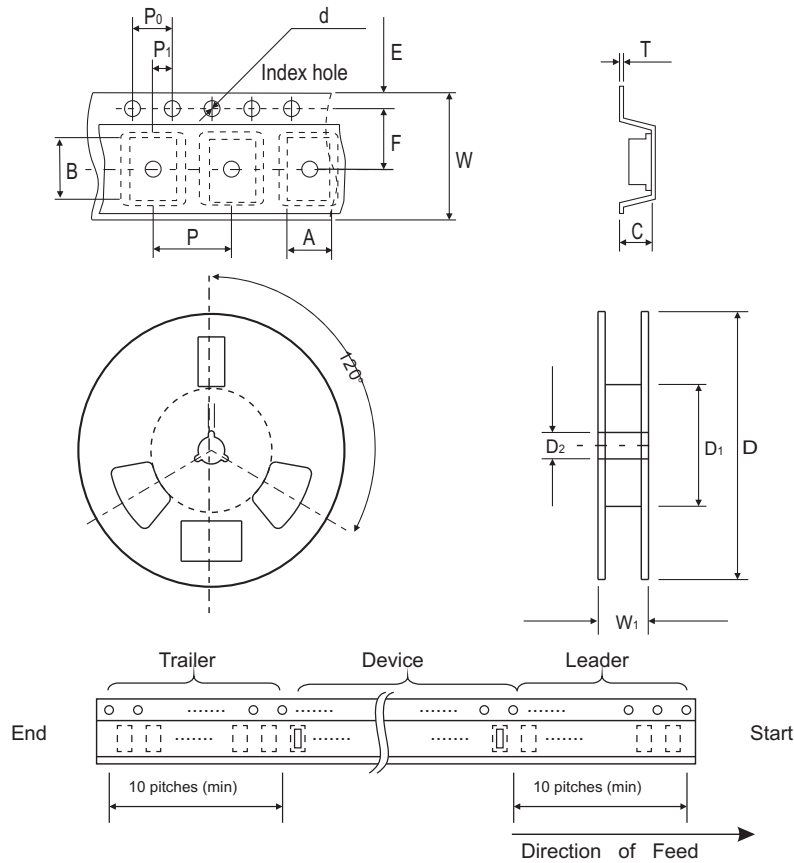

Fig.6 Capacitance vs. Reverse Voltage



Reel Taping Specification



	SYMBOL	A	B	C	d	D	D ₁	D ₂
	SOT-23-6	(mm)	3.17 ± 0.10	3.23 ± 0.10	1.37 ± 0.10	1.55 ± 0.10	178 ± 1	50.0 MIN.
(inch)		0.124 ± 0.004	0.127 ± 0.004	0.054 ± 0.004	0.061 ± 0.004	7.008 ± 0.040	1.969 MIN.	0.512 ± 0.008
SOT-143	(mm)	3.19 ± 0.10	2.80 ± 0.10	1.31 ± 0.20	1.55 ± 0.05	178 ± 1	50.0 MIN.	13.0 ± 0.20
	(inch)	0.126 ± 0.004	0.110 ± 0.004	0.052 ± 0.008	0.061 ± 0.002	7.008 ± 0.04	1.969 MIN.	0.512 ± 0.008
SOIC-8	(mm)	6.50 ± 0.10	5.30 ± 0.10	2.50 ± 0.20	1.50 ± 0.10	330 ± 1	50.0 MIN.	13.5 ± 1
	(inch)	0.256 ± 0.004	0.209 ± 0.004	0.098 ± 0.008	0.059 ± 0.004	12.992 ± 0.04	1.969 MIN.	0.531 ± 0.04

	SYMBOL	E	F	P	P ₀	P ₁	T	W	W ₁
	SOT-23-6	(mm)	1.75 ± 0.10	3.50 ± 0.05	4.00 ± 0.10	4.00 ± 0.10	2.00 ± 0.05	0.22 ± 0.05	8.00 ± 0.30
(inch)		0.069 ± 0.004	0.138 ± 0.002	0.157 ± 0.004	0.157 ± 0.004	0.079 ± 0.002	0.008 ± 0.002	0.315 ± 0.012	0.567 MAX.
SOT-143	(mm)	1.75 ± 0.10	3.50 ± 0.05	4.00 ± 0.10	4.00 ± 0.10	2.00 ± 0.10	0.22 ± 0.05	8.00 ± 0.20	14.4 MAX.
	(inch)	0.069 ± 0.004	0.138 ± 0.002	0.157 ± 0.004	0.157 ± 0.004	0.079 ± 0.004	0.008 ± 0.002	0.315 ± 0.008	0.567 MAX.
SOIC-8	(mm)	1.75 ± 0.10	5.50 ± 0.05	4.00 ± 0.10	4.00 ± 0.10	2.00 ± 0.10	0.22 ± 0.05	12.0 ± 0.20	18.4 MAX.
	(inch)	0.069 ± 0.004	0.217 ± 0.002	0.157 ± 0.004	0.157 ± 0.004	0.079 ± 0.004	0.008 ± 0.002	0.472 ± 0.008	0.724 MAX.

Suggested PAD Layout

SIZE	SOT-23-6		SOT-143		SOIC-8	
	(mm)	(inch)	(mm)	(inch)	(mm)	(inch)
A	1.10	0.043	0.70	0.028	2.40	0.094
B	0.60	0.024	1.40	0.055	0.70	0.028
C	0.95	0.037	2.41	0.095	1.27	0.050
D	2.50	0.098	0.80	0.031	2.50	0.098
E	3.60	0.142	3.60	0.142	7.30	0.287

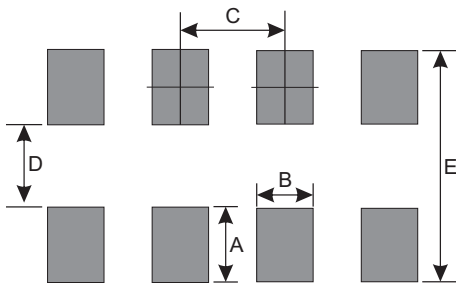
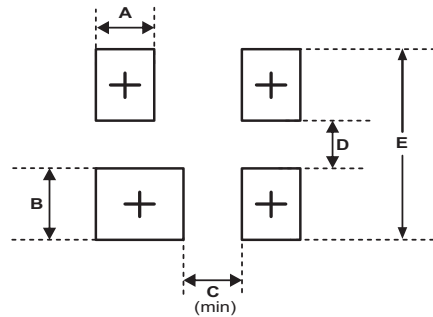
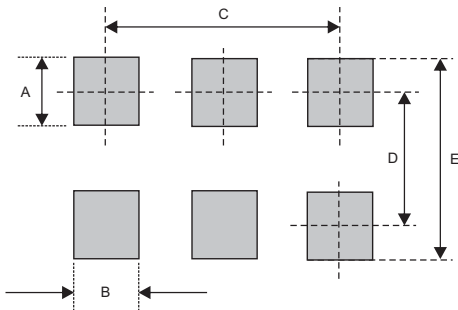

Standard Package

Case Type	Qty per Reel	Reel Size
	(Pcs)	(inch)
SOT-23-6	3000	7
SOT-143	3000	7
SOIC-8	2500	13